



LT5C Label Printer

User's Guide



□ **Manual Configuration**

The following manuals are included with the product.

- Residual Risk

This manual describes the map of residual risks that require protective measures by users.

- Setup Guide

This manual describes how to connect the printer to a computer and set it up following installation.

- User's Guide (This Manual)

This manual describes details about product functions and operations.

- Maintenance Guide

This manual describes how to replace consumables, and how to clean and maintain the product.

The latest versions of the manuals and installer can be downloaded at the Afinia Label website.

<https://afinialabel.com/LT5Cinfo>

□ Reading the Manual

Symbols



Note

- These are cautions and restrictions for the correct operation of the device. Make sure to read to avoid misoperation.



Memo

- These are references and information that are useful when using the device. We recommend reading them.



Reference

- These are the reference pages. Read to learn detailed information and relevant information.

WARNING





- Mishandling due to ignoring this display may cause death or serious injury.

CAUTION

- Mishandling due to ignoring this display may cause personal injury.

Keys, Buttons, and Symbols

This chapter describes the following keys, buttons, and symbols.

Inscription	Description
< > button/key	<ul style="list-style-type: none"> • Indicates hardware buttons and the numeric keypad on the control panel. E.g.: <div style="display: flex; justify-content: space-around; align-items: center;"> <div style="text-align: center;">  → <OK> button </div> <div style="text-align: center;">  → <BACK> button </div> </div> <div style="display: flex; justify-content: space-around; align-items: center; margin-top: 10px;"> <div style="text-align: center;">  → <Fn> key </div> <div style="text-align: center;">  → <CLEAR> key </div> </div> <ul style="list-style-type: none"> • Indicates your PC keyboard.
[]	<ul style="list-style-type: none"> • Indicates menu names on the display screen. • Indicates menu, window, and dialog names on the computer.
" "	<ul style="list-style-type: none"> • Indicates messages and input text on the display screen. • Indicates file names and screen names on the computer. • Indicates reference titles.
>	Indicates how to get to the item you want in the menu of this printer or the computer.

Illustrations

Unless otherwise specified, the printer illustrations used herein show the printer with the unwinder mounted.

Illustrations may differ from the actual product.

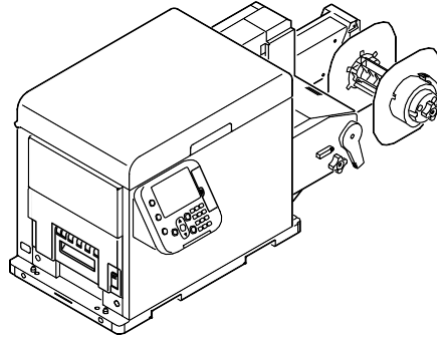

Screens

The images of the control panel and PC used herein are examples. The images may differ from actual products and screens.

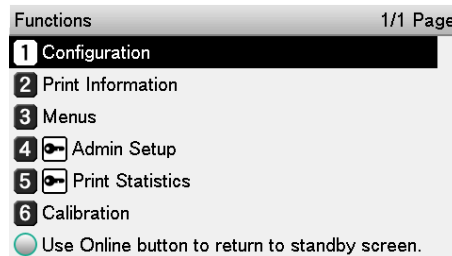

Inscriptions

The following inscriptions are used in this manual.

- Microsoft® Windows® 10 64-bit Edition operating system → Windows 10 (64-bit version)
- Microsoft® Windows® 10 operating system → Windows 10

Unless otherwise specified, the examples in the manuals included with the printer show operation using Windows 10 and the LT5C printer.

Depending on the OS, model, and version you are using, descriptions in this manual may differ from what you actually encounter.

□ Table of Contents

Manual Configuration	2
Reading the Manual	3
Symbols	3
Keys, Buttons, and Symbols	3
Illustrations	4
Screens	4
Inscriptions.....	4
1 Paper Settings	11
Printing on Various Papers	12
Usable Media Types	12
Paper Types, Size, and Thickness.....	12
Storing Media.....	14
Registering a Desired Paper Size with the Printer Driver	15
Using the Printer Driver to Fine-tune the Print Position	16
Using the Printer Driver to Fine-tune the Cut Position.....	18
2 Printing	21
Preparing Paper.....	22
Loading Media	24
Calibrating the Sensor.....	30
Confirming the Sensor Position.....	30
Unwinder	30
Printer.....	33
Sensor Calibration	35
If You Cannot Set the Sensors from the Printer Driver	37
Calibrating the Black Mark Sensor	38
Calibrating the Gap Sensor	40
Detecting the Interval between Pages	43
Printing	45
Canceling a Print Job.....	46
3 Print Function Settings	47
Printer Driver Functions Table	48
Explanation of Functions.....	48
Windows PCL Printer Driver Functions	48
Table of Setting Items in the Control Panel Menu Screen	50
Device Setup Screen	50
[Configuration].....	50

[Print Information]	52
[Menus]	53
[Admin Setup]	63
[Print Statistics]	74
[Calibration]	75
[Boot Menu]	78
Saving Toner When Printing	79
Saving Toner When Printing (Toner Save Mode)	79
Printing Using the Specified Print Cartridge Only (Lift Up)	80
Fine Quality Printing	81
Changing Print Quality (Resolution).....	81
Making Photograph Printing More Vivid (Photo Enhance).....	81
Adjusting Fine Lines.....	82
Using Printer Fonts	82
Using Computer Fonts.....	83
Adjusting the Print Position on the Paper	84
Using the roll paper	84
Adjusting the Position That Printing Starts	85
When using a black mark sensor.....	85
When using a gap sensor.....	85
Other Print Functions	87
Specifying the Page Order.....	87
Overlaying Stamps for Printing (Watermarks).....	87
Collating Printed Output (Sorted Printing)	88
Printing a Mirror Image	89
Printing Registered Forms (Print Overlay)	90
Outputting to a File Without Printing	92
Changing the Check Unnecessary Print Cartridge Setting	92
Saving Printer Driver Setups	93
Save a Setup	93
Recall a Saved Setup.....	94
Delete a Saved Setup.....	94
Importing/Exporting a Printer Driver Print Setup	95
Export a Setup	95
Import a Setup.....	95
Changing Default Printer Driver Settings.....	96
Deleting or Updating a Printer Driver	97
Deleting a Printer Driver	97
Updating a Printer Driver	98
4 Adjusting the Color	99
Adjusting Color with the Control Panel.....	100

Correcting Color Drift Manually	100
Configuring Settings for Auto Adjustment of Density and Gradation	100
Adjusting Density Manually	101
Fine Tuning Density Adjustments	102
Adjusting Color Balance (Density)	104
Fine-tuning Color Balance	106
Adjusting Color with a Printer Driver	109
Color Matching	109
What Is Color Matching?	109
Color Matching (Automatic)	109
Simple Color Matching (Simple Adjustment).....	110
Color Matching (Graphic Pro)	111
Color Matching (No Color Matching)	112
Changing the Black Finish	112
Monochrome (Black and White) Printing	113
Suppressing White Lines Between Text and the Background (Black Overprint).....	114
Correcting for Print Misalignment (Trapping).....	114
Simulating Print Results.....	115
5 Spot Color Printing Setup	117
Printer Driver Spot Color Function List.....	118
Printing on Color Papers	119
Usable Color Papers	119
Printing Using White Toner Only.....	119
Printing White Under Color.....	120
Fine-Tuning White Shading.....	121
6 Network Settings.....	123
Initializing Network Settings	124
Using DHCP	125
IPv6	127
Checking the IPv6 Address	127
7 Viewing Machine Information.....	129
Printing Configuration Information	130
Printable Report List.....	130
Printing Printer Setup Lists.....	131
Configuration	131
Printing Printer Information Lists	132
Demo Page	132
Error Log	133
Usage Report	133

Printing Print Lists.....	134
Color Profile List	134
User Media List.....	135
Test Print	135
Changing the Administrator Password	136
Checking the Print Count	138
8 Utility Software Usable with This Printer	139
Utility List.....	140
Using a Web Browser to Configure the Network Setup	141
Operating Environment	141
Starting Up	141
Logging in as an Administrator	142
Item List	143
Changing an Administrator Password	144
Checking Printer Settings From a Computer	145
Changing Printer Settings From a Computer	146
Encrypting Communication (SSL/TLS)	146
Printing with IPP.....	149
Encrypting Communication (IPsec).....	150
Controlling Access by IP Address (IP Filter)	157
Controlling Access by MAC Address	159
Sending Error Notifications by Mail.....	160
Sending Error Notifications by Periodic Mail	162
Using SNMPv3.....	166
Using IEEE802.1X.....	167
Network Extension	172
Operating Environment	172
Checking the Printer Settings	172
Uninstalling Network Extension.....	173
Index	174

1

Paper Settings

Printing on Various Papers	12
Registering a Desired Paper Size with the Printer Driver	15

 **Note**

- The examples in this chapter use Windows WordPad for explanations. Depending on the application, the screens and operations procedures may differ.
- For detailed explanations of the printer driver and utility setup items, see "Online Help".
- Due to printer driver and utility version upgrades, actual operations may be different from the descriptions in this manual.

□ Printing on Various Papers

Usable Media Types

For high-quality printing it is necessary to use paper that satisfies conditions regarding quality, thickness, paper finish, etc. If printing on paper not recommended by Afinia Label, thoroughly test the print quality and paper traveling performance, etc., and check that there are no impediments before use.

If using a (paper) medium that is curled or wrinkled before printing, print quality and paper traveling performance cannot be assured.

Paper Types, Size, and Thickness

■ Roll Paper Specifications



Reference

- Refer to the "Maintenance Guide" for specific paper sizes.

Roll Paper Types

Media Form	Description
Continuous Paper	Paper wound on a roll
Continuous Paper (Black Mark)	Paper wound in a roll with black marks printed on the back surface
Die-cut Label (Gap)	Paper that is die-cut into a label shape
Die-cut Label (Black Mark)	Paper that is die-cut into a label shape with black marks printed on the back surface
Continuous Label	Paper that is not die-cut into a label shape, with the entire surface covered with label paper
Continuous Label (Black Mark)	Paper that is not die-cut into a label shape, with the entire surface covered with label paper and black marks printed on the back surface

Media Type	Description
Plain	Wood-free Paper
Plain Labels	Label paper made of wood-free paper
Glossy Labels	Label paper made of glossy paper
Film Labels	Label media made of film
Film	Film

Roll Paper Size

Roll Outside Diameter	No greater than 203.2 mm (8 inches)
Paper Width	25.4 to 130 mm (1 to 5.12 inches)
Paper Thickness	0.07 mm to 0.25 mm* (0.003 to 0.0098 inches)
Roll Core Width	Same as roll paper
Roll Core Inner Diameter	76.2 mm



Note

* When there is backing paper, total thickness includes backing paper.

- Using metal foil paper or conductive paper creates the risk of defective printing due to electrical discharge, and device malfunction.
- Use paper that has black marks printed on its back surface (non-printing surface). Black marks printed on the front surface cannot be detected.
- Use paper with black marks printed with carbon ink. Use paper with black marks that have a reflective index of less than 10%.

- Die-cut labels that are used in Gap Mode must satisfy the following conditions.
The transparency of the label part (including both the label and the label liner) must be below 25%.
The liners must be within a range of 10% to 45% transparent. However, the transparency of the liners must be more than 1.8 times the transparency of the label part.
- Die-cut labels that are used in Gap Mode cannot use transparent liners or labels.
- Die-cut labels that are used in Black Mark Mode cannot use transparent liners.
- Use continuous labels that have been smoothed on both edges and have been dry edge processed. Recommended specifications are for paper that has 2 mm of liner on both edges. Please refer to the "Maintenance Guide" for details.
- Thermal paper will become discolored and deformed by heat used for fusing. Do not use it.
- Use film that can withstand heat up to 230°C. Use of film that is not heat resistant creates the risk of film deformation by heat used for fusing, paper jams, and device malfunction.
- Do not use a liner on which glue is smeared. It will not feed correctly in the equipment. In the worst case, it could damage the equipment.
- Cast-coated paper is not recommended. Printing quality cannot be guaranteed when it is used.
- If the paper length, label length, or black Mark Interval for a single sheet is less than 4 inches, blank sheets may be printed to satisfy the paper length that can be fed.
- When printing on paper that is cut to less than 152 mm (6 inches) long in the direction that media is fed, it may feed at an angle.
If this happens, print it so there is a continuous length that is longer than 152 mm (6 inches).
- When printing on paper that is very narrow (25.4 mm (1 inch)), it may feed at an angle at about 80 mm from the cut trailing edge.
- When printing on inside winding paper that is very narrow (25.4 mm (1 inch)), smeared or smudged printing may occur near the cut trailing edge as the roll diameter gets smaller.
- When printing on inside winding paper that is very narrow (25.4 mm (1 inch)), slight damage may occur at the leading edge as the roll diameter gets smaller.
- Use of the types of paper below is not supported.
 - Paper whose roll surfaces are not cut cleanly.
 - Paper that is connected part way through by tape, etc.
 - Label paper without backing paper with paste on the front surface
 - Paper whose labels are easy to peel or are peeling
 - Paper with paste squeezing out onto the base paper area or affixed to the label surface
 - Paper that is folded or bent
 - Paper that has holes in it
 - Paper that is notched
 - Paper that has perforations
 - Paper with different size labels on a single roll
 - Paper with different paper widths on a single roll
 - Media that has liners and labels that are both transparent (cannot be used even if it has black marks)
 - Continuous paper that is transparent (cannot be used even if it has black marks)

■ Setting the Paper Weight

Set the printer and printer driver paper weight according to the weight of the paper to be used.

Paper Weight (Total thickness including backing paper)	Setting Value of the Media Weight
76 to 95 μm	Light
96 to 140 μm	Medium Light
141 to 159 μm	Medium
160 to 180 μm	Medium Heavy
181 to 199 μm	Heavy
200 to 214 μm	Ultra Heavy1
215 to 229 μm	Ultra Heavy2
230 to 249 μm	Ultra Heavy3

Storing Media

Improper paper storage can cause absorption of moisture, discoloration, and warping. Note that printing on such paper can adversely affect print quality, feeding, etc. Leave packages of media unopened until you are actually ready to use them.

■ Store media in locations like the ones described below

- On a flat shelf in a location that is dark and where there is little moisture
- On a flat table
- An environment with a temperature of 23°C ±1°C and humidity of 50%RH ±2%

■ Avoid locations like the ones described below

- Directly on the floor
- In direct sunlight
- Near the inside surface of an external wall
- On a surface that is uneven or curved
- In a location where electrostatic charge is generated
- In a location subjected to very high temperatures or sudden temperature changes
- Next to a photocopying machine, air conditioning equipment, heater, or duct



- Proper printing may not be possible on paper that has been stored for a long time.
- Leaving roll paper in an environment where it is exposed to high temperatures and high humidity for long periods can cause it to become deformed. Do not use deformed roll paper. Store roll paper in an environment where the temperature and humidity are appropriate.
- We recommend putting partially used label paper back into the vinyl bag it was packaged in, to prevent the paper from absorbing moisture.

□ Registering a Desired Paper Size with the Printer Driver

1 Click [Start] and select [Control Panel] in [Windows System].

2 Click [View devices and printers].

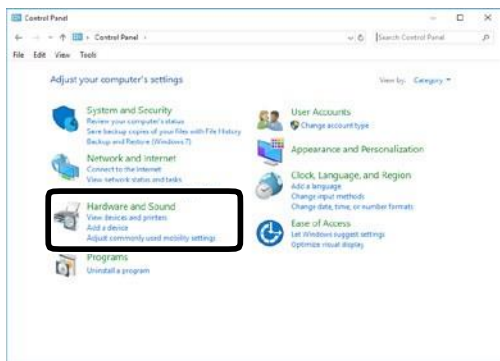

3 Right-click the [LT5C PCL6] icon, and then select [Printing preferences].

4 On the [Setup] tab, click [User-defined paper].

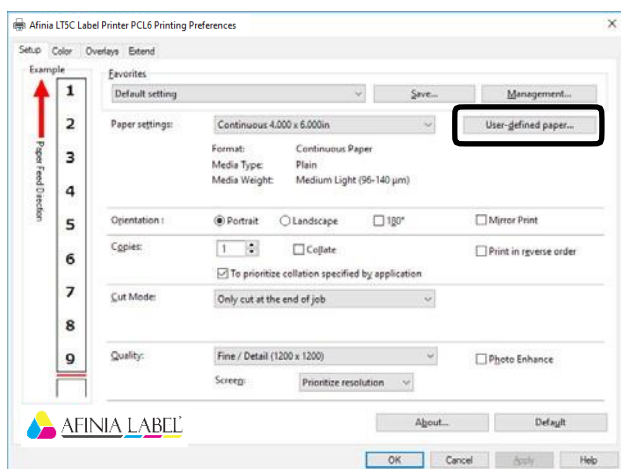

5 Input information about the paper you want to register.

- (1) Use [Registered user-defined paper] to select "New Paper".
- (2) In the [Paper Name] box, enter a paper name.
- (3) Select a Media Form to match the paper.
- (4) Select a Media Type to match the paper.

(5) Select a Media Weight to match the paper thickness.



- If you are unsure of the paper thickness, select [Medium Light].

(6) Enter paper size information.

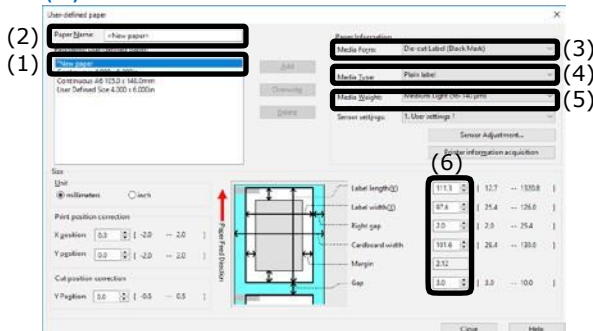

- Input the label length and gap for media that has gaps and the black mark interval for black mark media.
- Use a ruler to measure, as accurately as possible, the actual size of the media, and then input those values.
- If the label length or the black mark interval is less than 4 inches, use the following method to measure the media, and then input values to the first decimal place to be accurate.

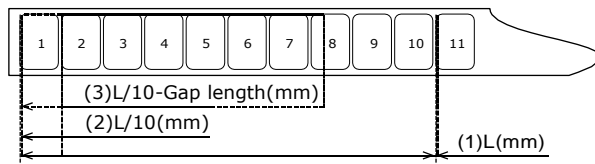

How to Measure the Actual Size of Paper

- (1) Measure the length from the leading edge of the first label (or black mark leading edge) to the leading edge of the 11th label (or black mark leading edge). Use this as L (mm).
- (2) Divide the length you measured in (1) by 10 to calculate the length from the leading edge of the first label (or black mark leading edge) to the leading edge of the 2nd label (or black mark leading edge) to the first decimal place.
- (3) Subtract the length of the gap from the length you calculated in (2) to calculate the length of one label to the first decimal place.

For media that has gaps, input the value calculated in (3) in [Label length] and input the gap length in [Gap].

For media that has black marks, input the value calculated in (2) in [Black Mark Interval].

Memo

- A blank piece of paper may be inserted after cut pages if the paper length, label length, or black mark interval is less than 4 inches.

6 Enter other information as required.

(1) If you performed sensor adjustment, select the sensor setting that was registered to the device from [Sensor settings].

Memo

- Refer to “Calibrating the Sensor” (P.30) regarding how to adjust the sensor.

(2) If you want to fine-tune the image position, enter the position shift amount into [Print position correction].

(3) If you want to fine-tune the paper cut position, enter the position shift amount into [Cut position correction].

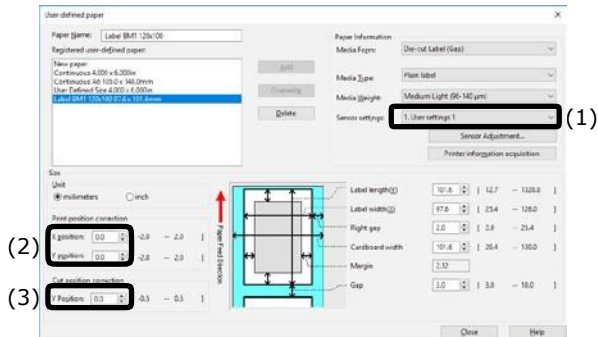

7 When all the input is complete, click [Add].

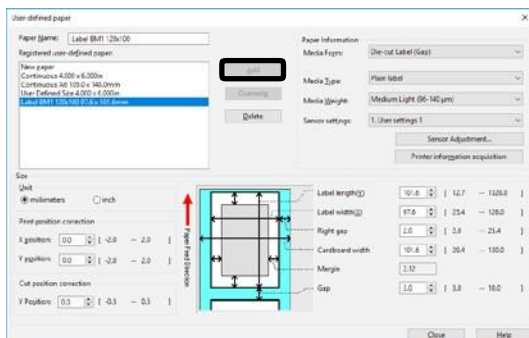

Using the Printer Driver to Fine-tune the Print Position

1 Click [Start] and select [Control Panel] in [Windows System].

2 Click [View devices and printers].

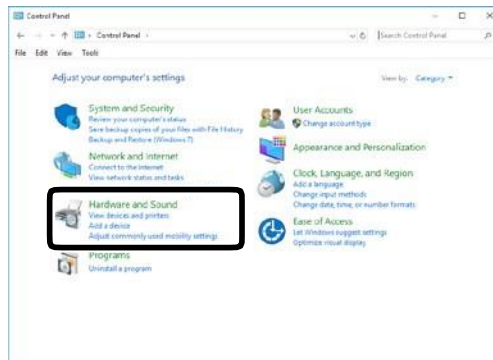

3 Right-click the [LT5C PCL6] icon, and then select [Printing preferences].

4 On the [Setup] tab, click [User-defined paper].

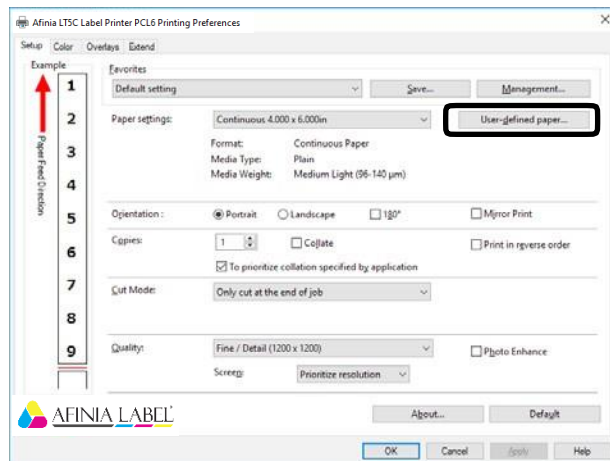

5 Use the [Registered user-defined paper] list to select the paper whose print position you want to correct.



- If the paper you want to use is not in the list, select [New paper] and add it. See "Registering a Desired Paper Size with the Printer Driver" (P.15).

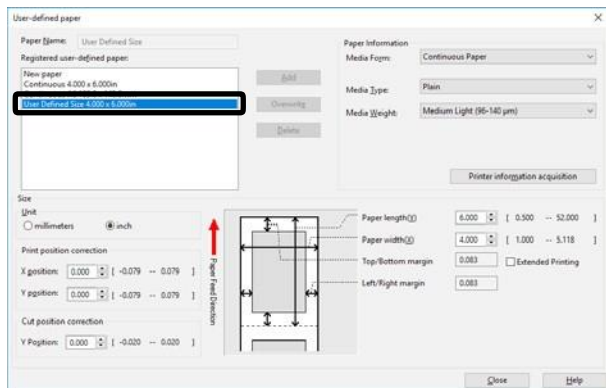

6 In [Print position correction], set the values for the print start positions vertically and horizontally on the paper.

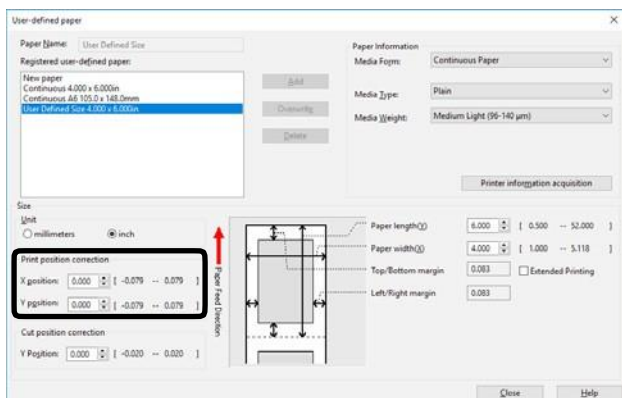

7 Click [Overwrite].

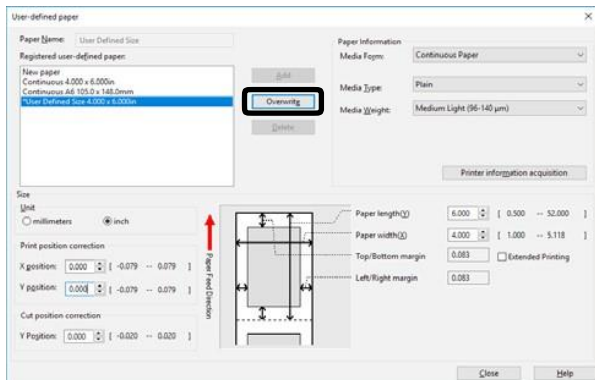

8 Click [OK] or [Close] as many times as necessary to exit the "Printing preferences" screen.

9 Open the file to be printed.

10 Specify the paper size, and then print.

Using the Printer Driver to Fine-tune the Cut Position

- 1 Click [Start] and select [Control Panel] in [Windows System].
- 2 Click [View devices and printers].
- 3 Right-click the [LT5C PCL6] icon, and then select [Printing preferences].
- 4 On the [Setup] tab, click [User-defined paper].

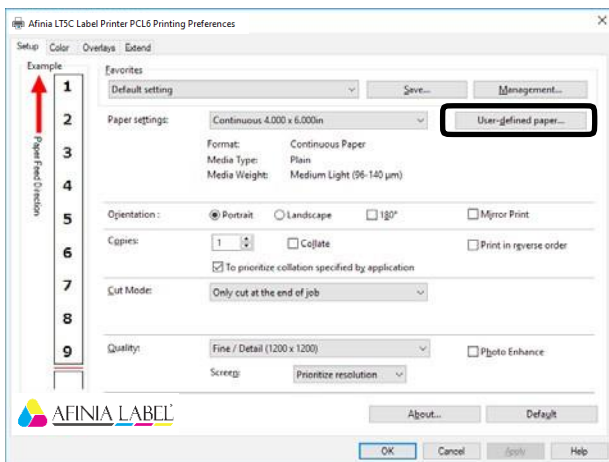

- 5 Use the [Registered user-defined paper] list to select the paper whose cut position you want to correct.



- If the paper you want to use is not in the list, select [New paper] and add it. See "Registering a Desired Paper Size with the Printer Driver" (P.15).

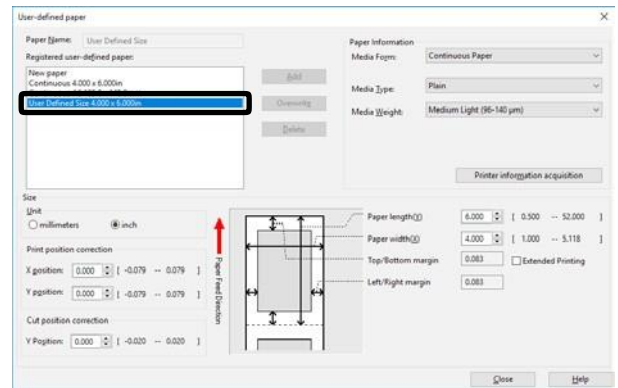

- 6 Use [Cut position correction] to specify an adjustment value for distance from the print completion position to the cut position.

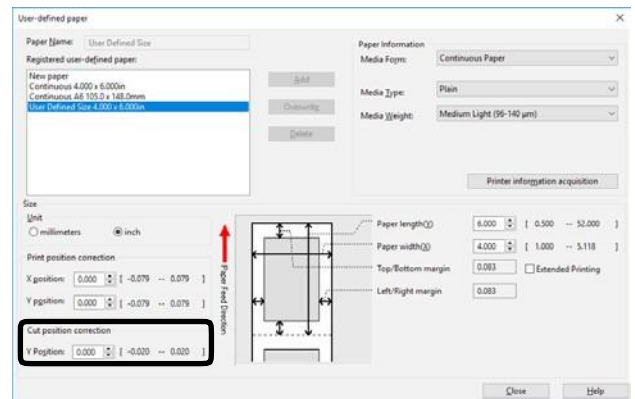

- 7 Click [Overwrite].

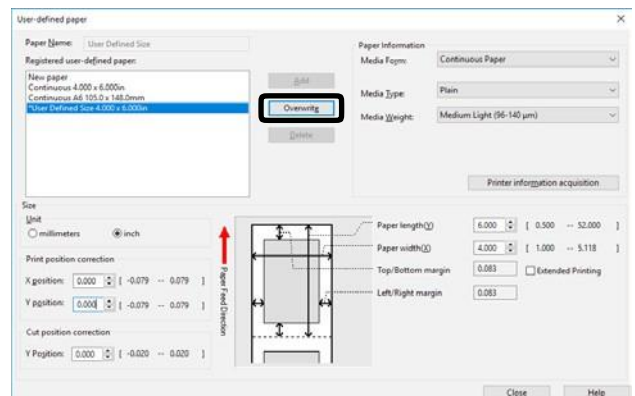

- 8 Click [OK] or [Close] as many times as necessary to exit the "Printing preferences" screen.
- 9 Open the file to be printed.
- 10 Specify the paper size, and then print.

2

Printing

Preparing Paper	22
Loading Media	24
Calibrating the Sensor	30
Detecting the Interval between Pages	43
Printing	45
Canceling a Print Job	46

 **Note**

- The examples in this chapter use Windows WordPad for explanations. Depending on the application, the screens and operations procedures may differ.
- For detailed explanations of the printer driver and utility setup items, see "Online Help".
- Due to printer driver and utility version upgrades, actual operations may be different from the descriptions in this manual.

□ Preparing Paper

This section describes how to load paper onto the holder of the unwinder.

For paper sizes and types that can be loaded onto the unwinder, see “Roll Paper Specifications” (P.12).

- 1 Remove the paper from the packaging.
- 2 Take care of the tape that is holding the leading edge of the paper.
If there is no tape holding the leading edge of the paper, you can just load it as is.

- (1) Remove the tape that is holding the leading edge.



Note

- Remove the tape that is holding the leading edge of the paper before you use it. Do not load paper while the tape is still attached and feed it into the equipment. There is a risk of damaging the equipment.

- (2) Cut off the part of the paper on which there is leftover adhesive.



Note

- There is a risk of adhesive being left over after removing the tape. If paper that still has adhesive on it is fed into the equipment, the adhesive may stick to the feed path and damage the equipment.

Cutting off the part of

the paper on which there is leftover adhesive (2) Tape is removed (1)

Adhesive from tape

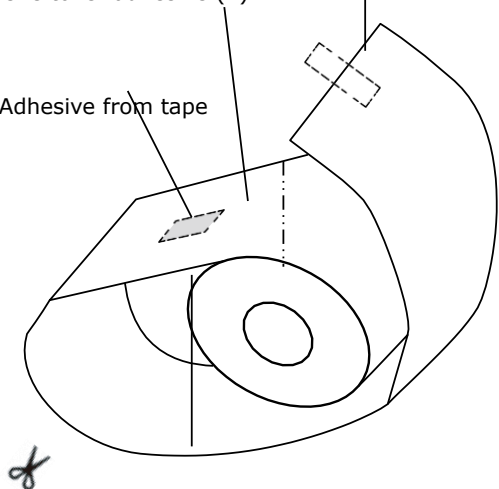

- 3 Check the leading edge of the paper and cut it off straight.

If the leading edge of the paper is cut straight, you can just load it as is.

Be particularly careful when replacing paper and after removing and reloading jammed paper.

- (1) When loading paper, cut the leading edge of the paper straight before loading it.



Note

- Do not cut at an angle, do not cut black marks, and do not cut labels. Depending on the size and shape of the leading edge, there is a risk of skewing the print position, not being able to print, or damaging the equipment.
- Standard media and continuous labels (dry edge)

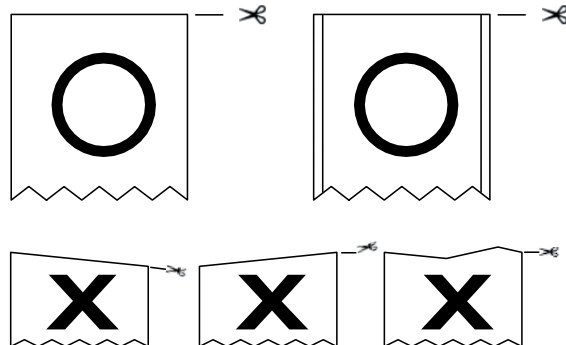

- Standard media (with black marks) and continuous labels (dry edge)

1.2 to 4.0 mm
(0.0472 to 0.1575 inches)
Length of leading margin when paper is loaded

1.2 to 4.0 mm
(0.0472 to 0.1575 inches)
Length of leading margin when paper is loaded

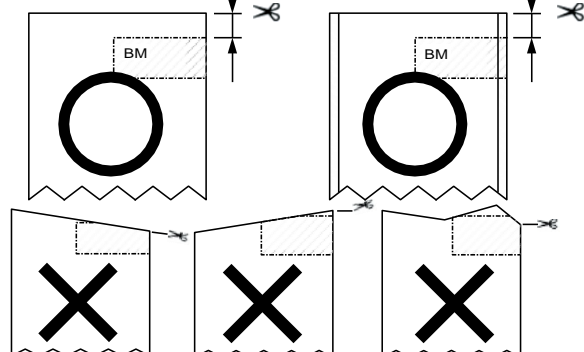

- Die-cut label paper (no black marks)

1.2 to 6.5 mm
 (0.0472 to 0.2559 inches)
 Length of leading liner
 when paper is loaded

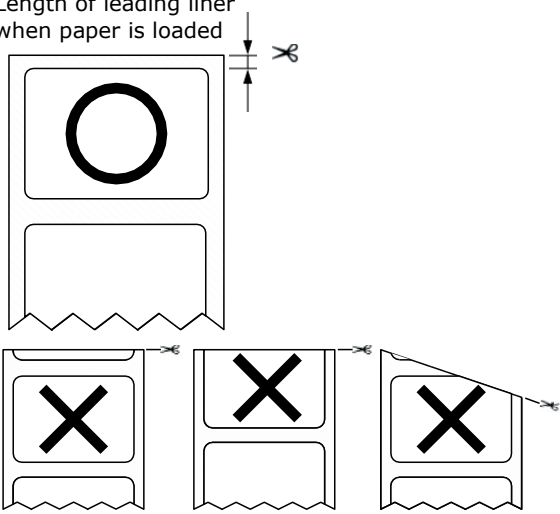

- Die-cut label paper (with black marks)

1.2 to 4.0 mm
 (0.0472 to 0.1575 inches)
 Length of leading margin
 when paper is loaded

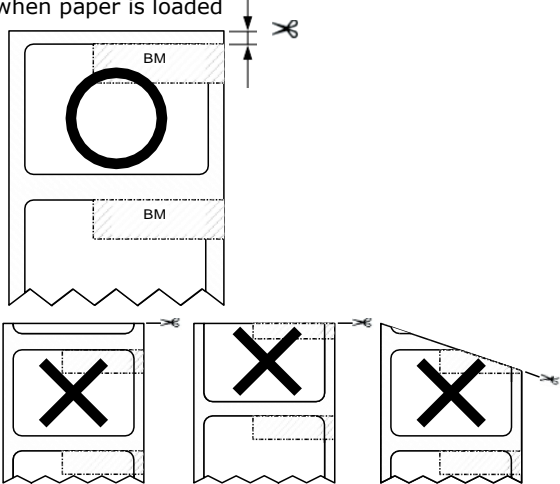

□ Loading Media

Load the paper onto the Unwinder. For paper sizes and types that can be loaded on the Unwinder, see “Roll Paper Specifications” (P.12).

! Note

- When setting roll paper, be careful not to drop it. As roll paper is heavy, when you drop it, there is a risk of injury.
- If you drop roll paper, it may roll on the floor and cause injury to the people around.
- To prevent roll paper from dropping, store it horizontally on a desk, etc.
- Do not use any roll paper that is not specified by the Roll Paper Specifications.

📝 Memo

- If the printer is turned OFF, press the <POWER> button to turn it on.

1 Open the Flange Locking Lever.

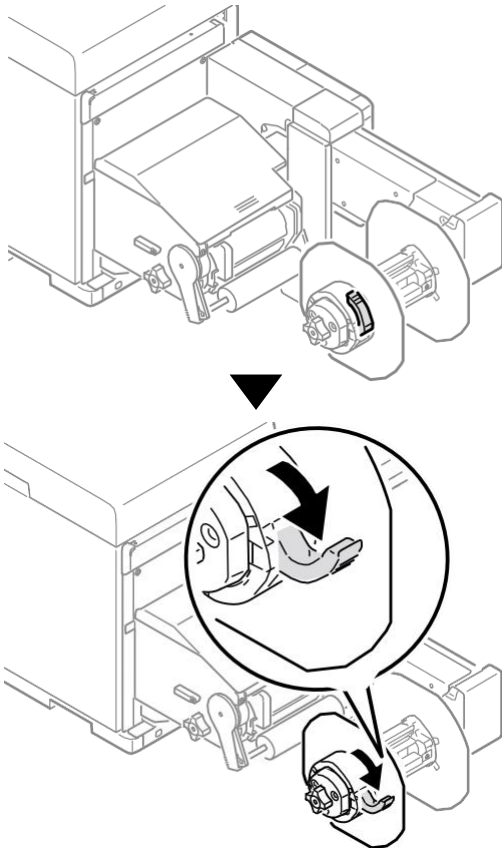

2 Remove the flange.

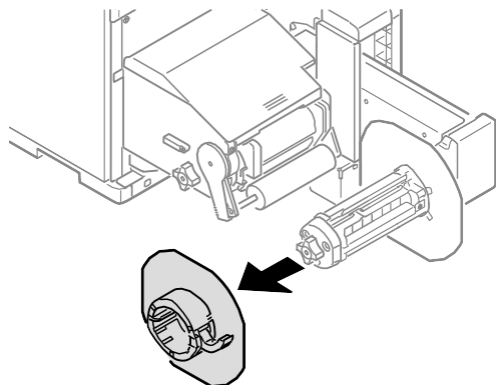

3 Rotate the Roll Paper Holder Knob to contract the Roll Paper Holder shaft.

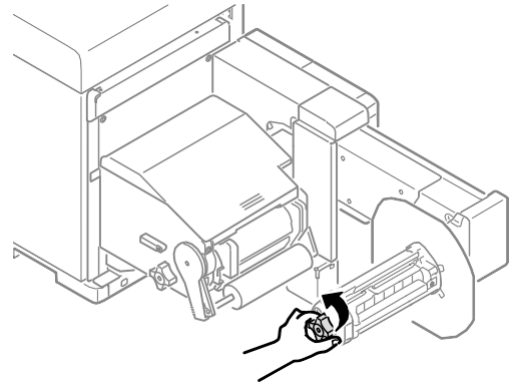

- 4** Slide roll paper onto the Roll Paper Holder shaft as far as it will go.

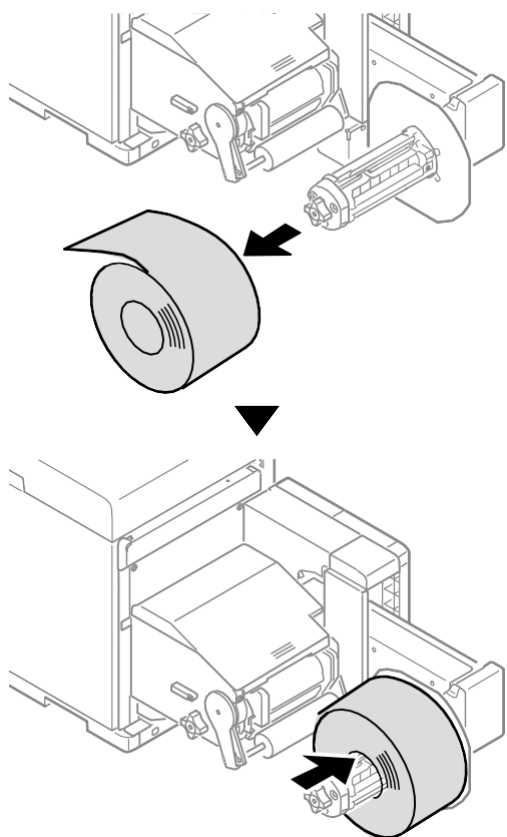

Note

- Make sure to slide the roll paper as far as it will go. Insufficiently sliding the roll paper can adversely affect print position accuracy.
- Take care to avoid pinching your fingers or hands when sliding the roll paper.

- 5** Rotate the Roll Paper Holder Knob to fix the roll paper core in place.

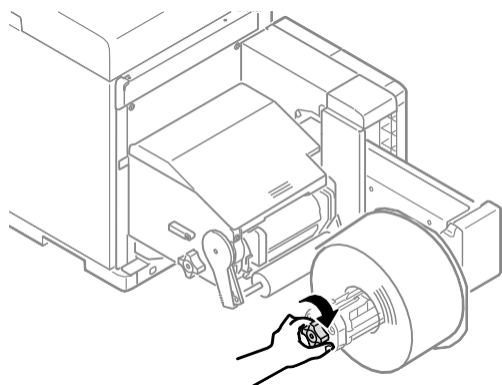

Note

- Rotate the Roll Paper Holder Knob until it clicks.

- 6** Aligning the Flange with the Roll Paper Holder shaft as shown in the illustration, attach the Flange.

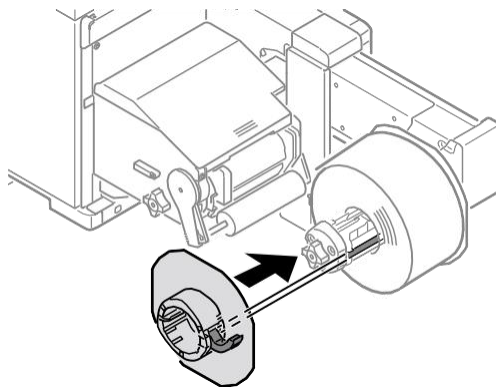

- 7** Slide the Flange as far as it will go in accordance with the roll paper width.

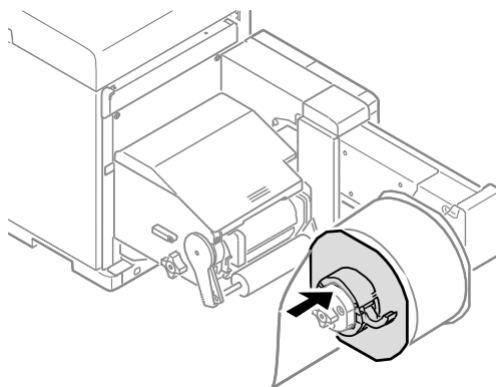

Note

- Slide the Flange up to the side of the loaded roll paper.
- Take care to avoid pinching your fingers or hands when attaching the Flange.

8 Close the Flange Locking Lever.

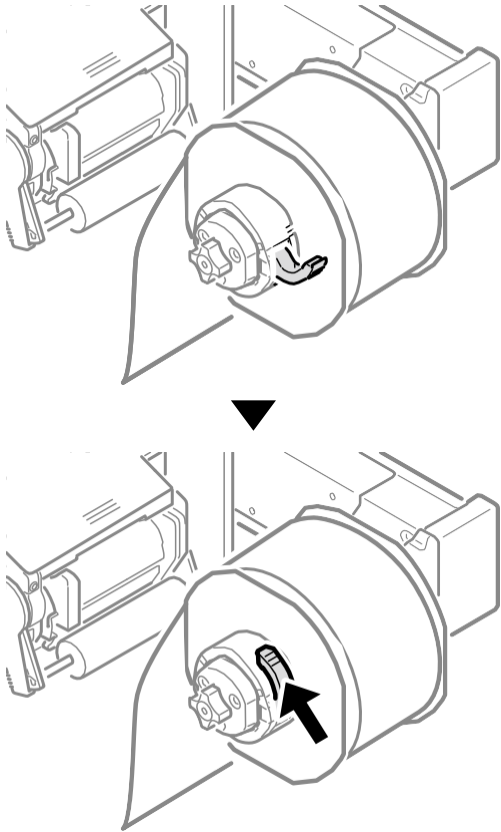

Note

- After loading roll paper, take care not to rest your body weight on the top of the Roll Paper Holder shaft. Doing so risks causing injury due to the device falling.

9 Lower the Unwinder Cover Open Lever to open the Unwinder Cover.

Open the Unwinder Cover manually in the direction indicated by the arrow until it locks.

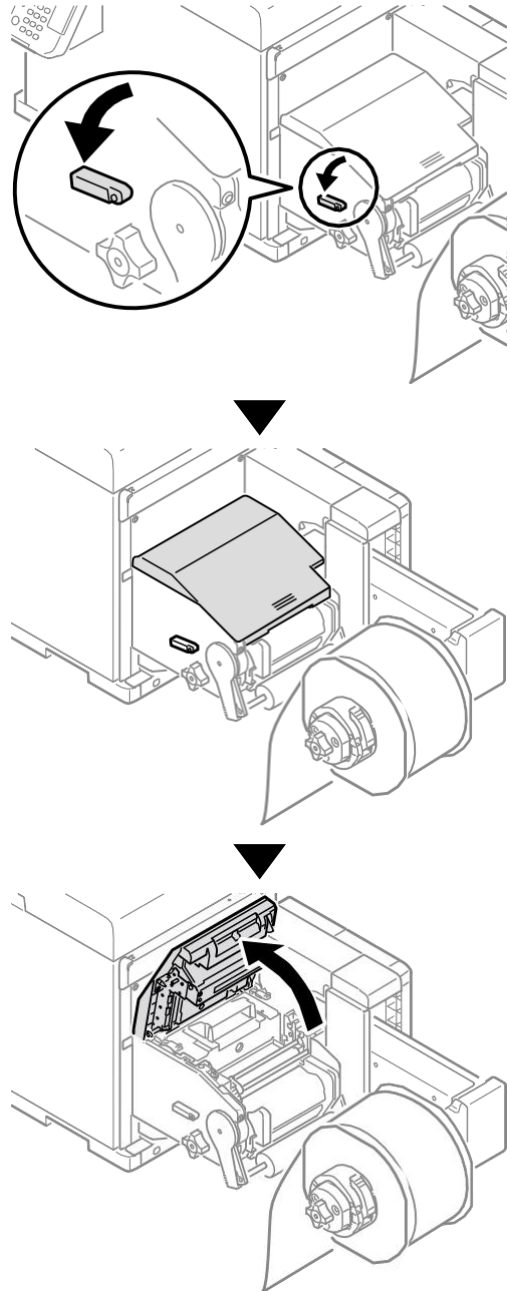

Note

- Open the Unwinder Cover until it locks securely.

10 Before loading the paper, rotate the Roll Paper Guide Adjustment Knob clockwise and move the Roll Paper Guide towards you.

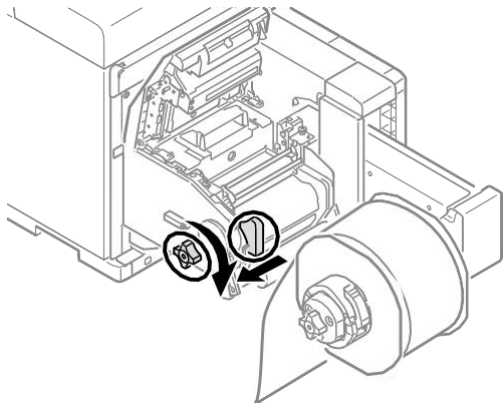

11 Pull up the F0 Roller Release Lever.



12 Press the Tension Bar Open Lever upwards until it clicks.

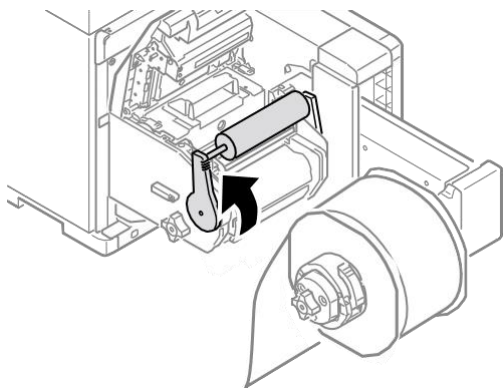

13 Pass paper below the Tension Bar and F0 Roller, and align the leading edge of the paper with the Roll Paper Guide and Paper Guide.

Roll Paper Guide
*D shape metallic pin

Paper Guide

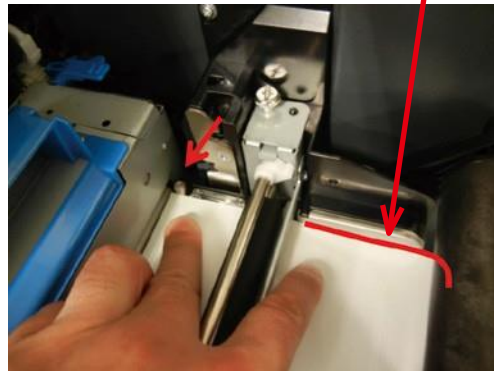

14 Check the paper status from the direction indicated by the arrow.

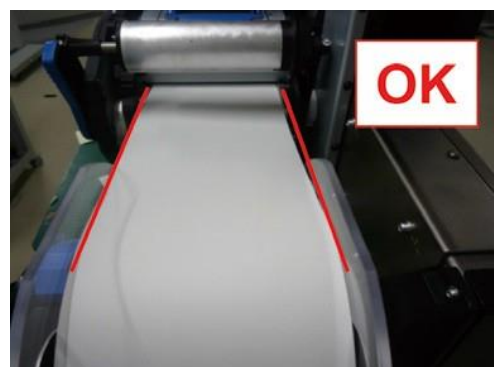
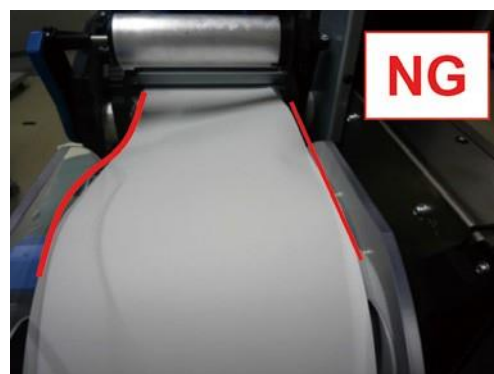
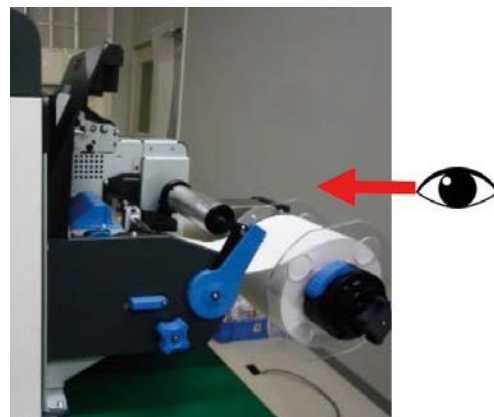

15 Rotate the Roll Paper Position Adjustment Dial to adjust the paper until it is straight.

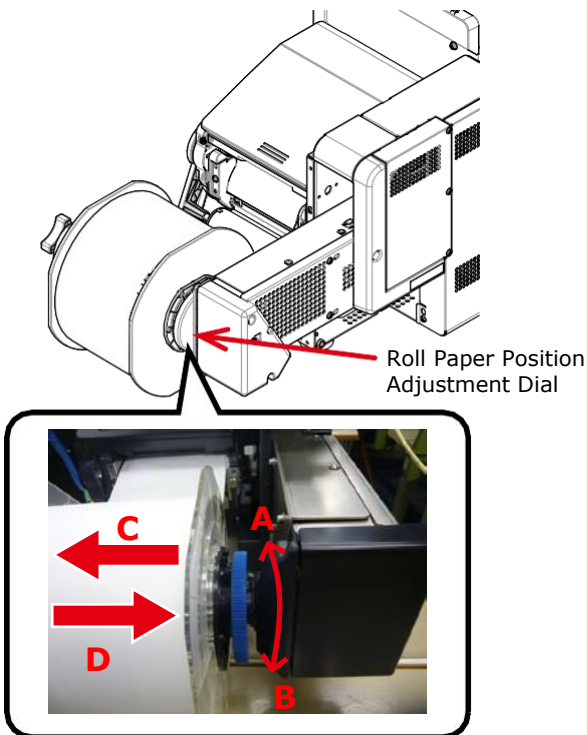

 Memo

- If you rotate the Roll Paper Position Adjustment Dial in direction A→the roll paper moves in the direction C
direction B→the roll paper moves in the direction D

16 Lower the F0 Roller Release Lever to fix the roller in place.

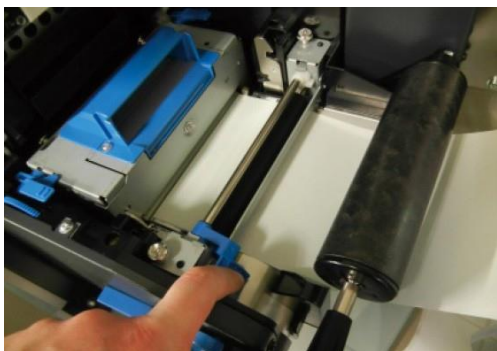

17 Press down on the Tension Bar Open Lever until it clicks.



18 After loading the paper, rotate the Roll Paper Guide Adjustment Knob counterclockwise and align the Roll Paper Guide to the width of the paper.

 Note

- Set the Roll Paper Guide correctly. If the Roll Paper Guide is not set correctly, the width of the paper cannot be detected correctly.
- Be careful that the Roll Paper Guide does not press too strongly on the paper. Doing so could damage the paper.
- Do not allow too much of a gap between the paper and the Roll Paper Guide. Doing so could allow the paper to twist and the print position to shift.
- When setting the Roll Paper Guide to the width of the paper, rotate the Roll Paper Guide Adjustment Knob counterclockwise, as shown in the following diagram, to make the Roll Paper Guide narrower so it matches the width of the paper. If it is too narrow, rotate the Roll Paper Guide Adjustment Knob clockwise to first open the Roll Paper Guide wider, and then make it narrower.

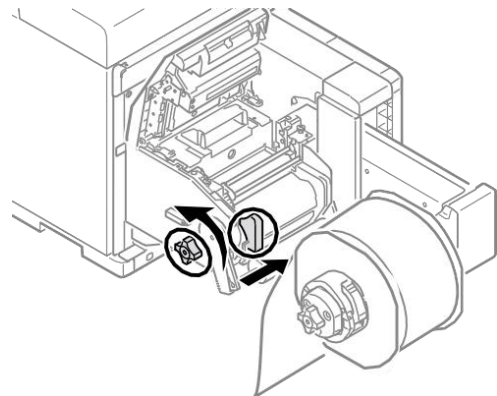

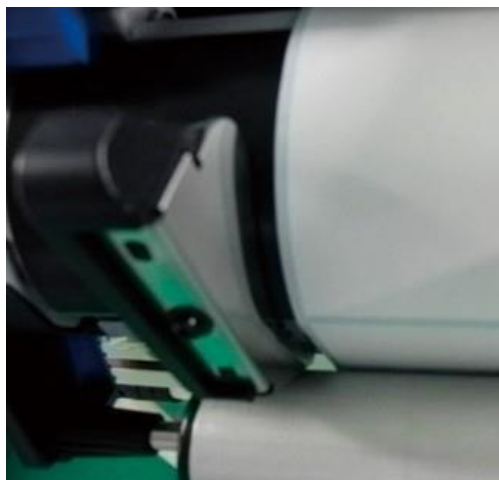

Gap is too large

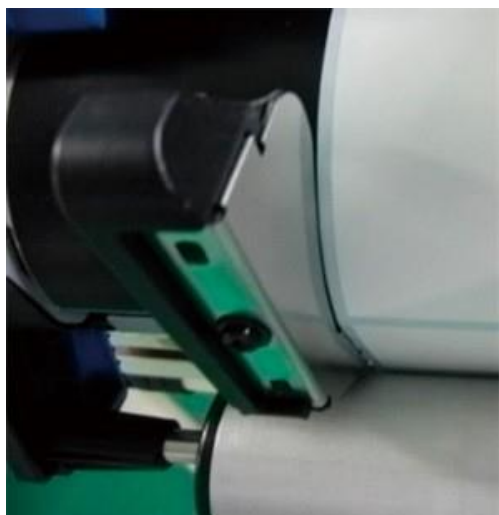

Roll Paper Guide is aligned to width of paper



Roll Paper Guide is too tight

19 Close the Unwinder Cover.

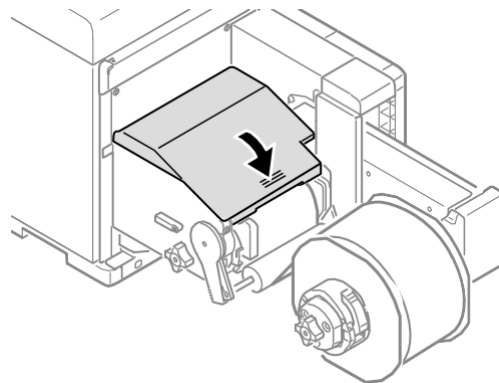

Note

- When closing the Unwinder Cover, there is a risk of pinching your fingers or hands. Press the top of the Unwinder Cover to close it.

This completes setting roll paper.



Memo

- If, even though the roll paper is set correctly, the paper separates from the Unwinder Paper Guide during printing, rotate the Roll Paper Position Adjustment Dial in the B direction to adjust it so the paper does not separate from the Unwinder Paper Guide.

As a guideline, the adjustment should be the same distance that the paper is separated from the Unwinder Paper Guide.

Each notch on the adjustment scale at the base of the Roll Paper Position Adjustment Dial is 1 mm.

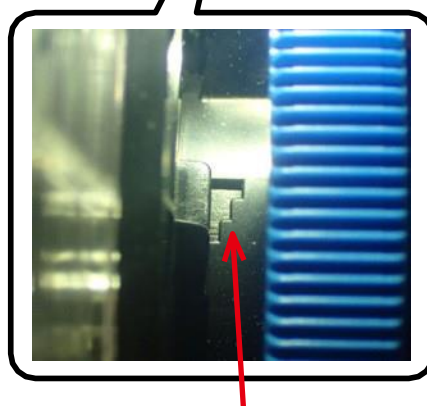
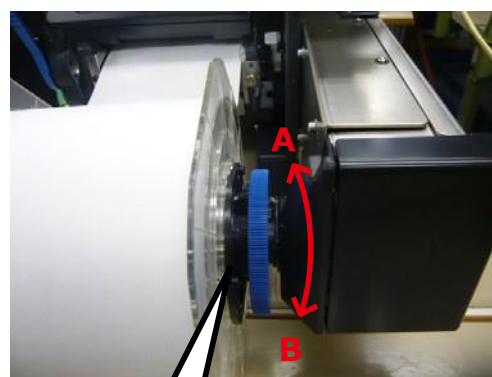

Adjustment notches

□ Calibrating the Sensor

! Note

- Check the position of the sensor each time you load paper. Check the position of the sensor in the following cases especially.
 - When you load a different type of paper
 - When you switch the type of sensor from black mark sensor to gap sensor
 - When you switch the type of sensor from gap sensor to black mark sensor
- If the sensor position settings do not match, paper feed jams may occur, you cannot adjust the black mark sensor or the gap sensor, and the skew in the adjusted values may cause the print position to skew.

Confirming the Sensor Position

Unwinder

- 1 Lower the Unwinder Cover Open Lever to open the Unwinder Cover.

Open the Unwinder Cover manually in the direction indicated by the arrow until it locks.

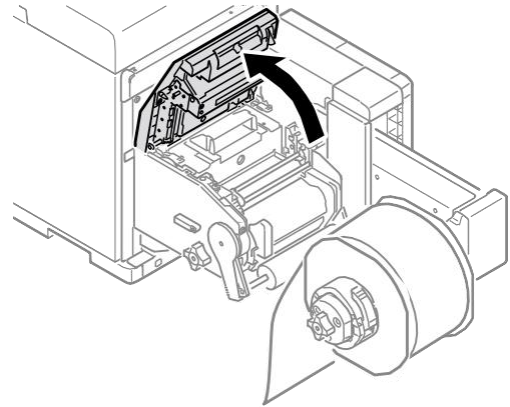
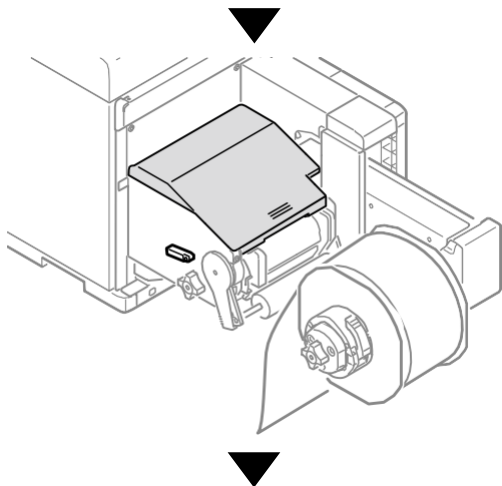
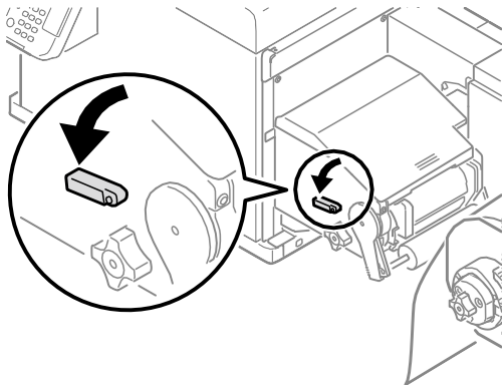

! Note

- Open the Unwinder Cover until it locks securely.

2 Confirm the sensor position.

Sensor Position Adjustment Dial

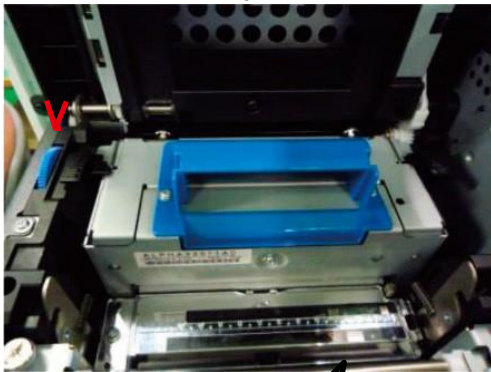

Position During Regular Usage
Factory setting is this position.

10 mm from edge of paper

The "Δ" indicates the black mark sensor position

Edge of paper

The "|" indicates the gap sensor position

16.5 mm from edge of paper

Edge of paper

- (1) Check the black mark sensor position
Align the paper, and check the actual position of the black mark and the black mark sensor position.

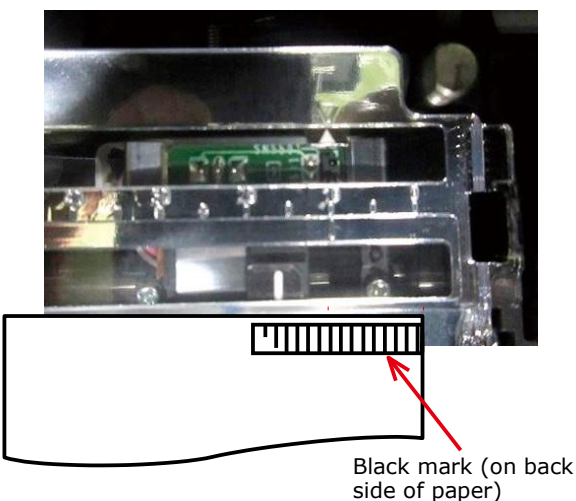

If the position of the black mark and the black mark sensor position do not align, rotate the Sensor Position Adjustment Dial to adjust the position (go to step 3).

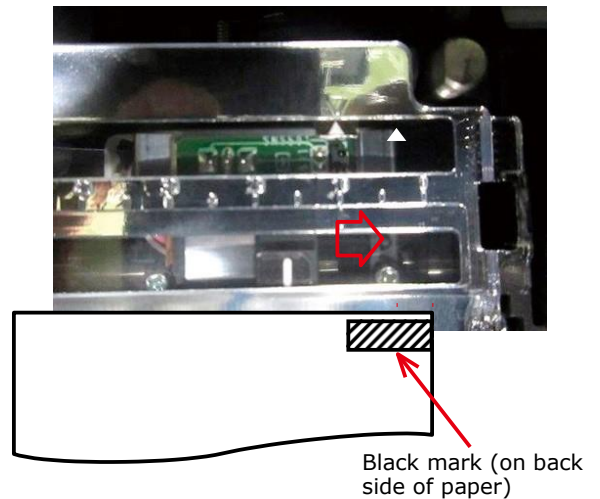

The black mark sensor position is set 10 mm from the edge of the paper.
If the black mark is 15 mm or more from the edge of the paper, you do not need to adjust it.
If the black mark is 15 mm or less from the edge of the paper, adjust the position of the Δ so it is in the center of the black mark.

- (2) Check the gap sensor position
Align the paper, and check the actual position of the label and the gap sensor position.

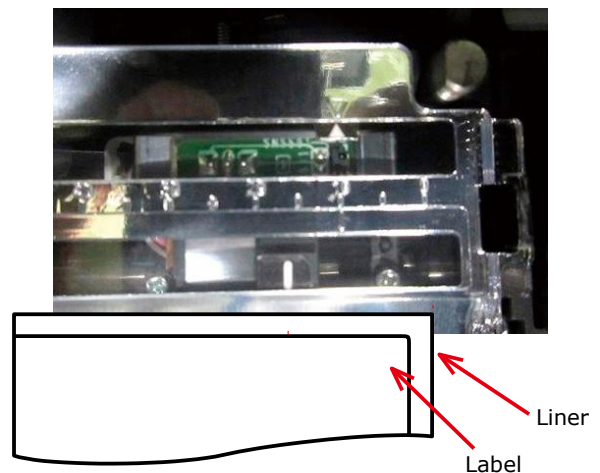

If the position of the label and the gap sensor position do not align in relation to the regular usage position, rotate the Sensor Position Adjustment Dial to adjust the position (go to step 3).

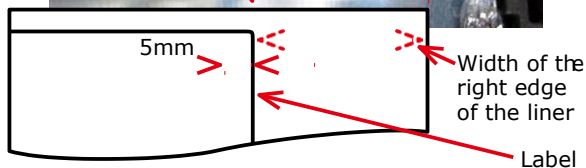
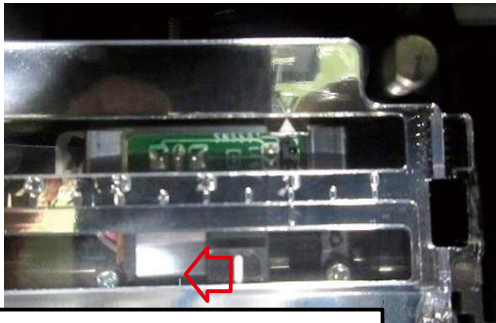

The gap sensor position is set 16.5 mm from the edge of the paper.

If the width of the right edge of the liner is 10 mm or less, then adjustments are not necessary.

If the width of the right edge of the liner is 10 mm or more, then adjust the gap sensor using the above positions as a rough estimate.

If the corners of the label are rounded, then consider the position of the radius of the corner.

Refer to the following example of adjusting the position.

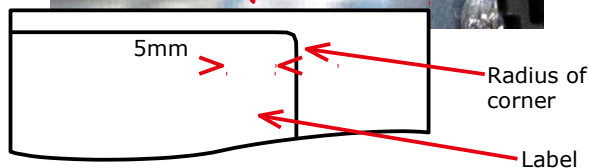
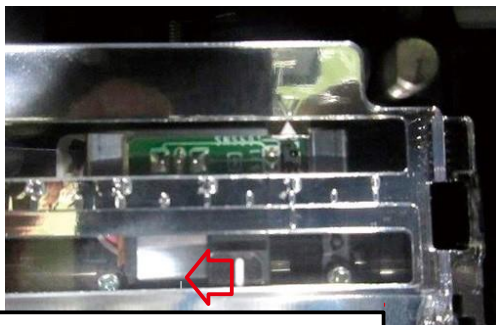

3 Rotate the Sensor Position Adjustment Dial to adjust the sensor position.

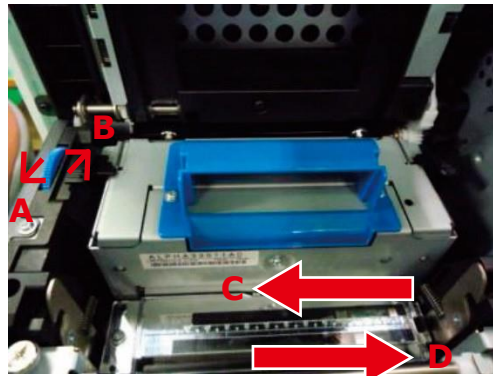

Memo

- If you rotate the Sensor Position Adjustment Dial in direction A→the sensor position moves in the direction C
direction B→the sensor position moves in the direction D

Printer

- 1 Grasping the Top Cover Open Lever, open the Top Cover.

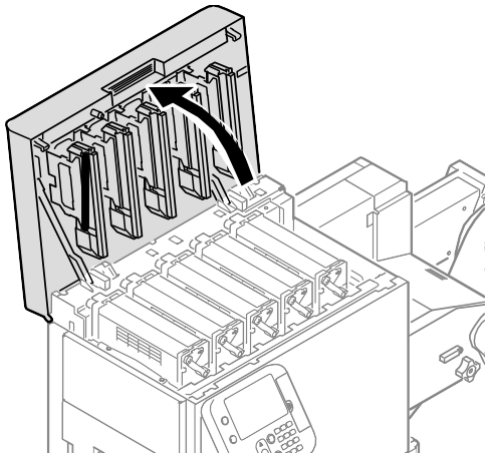

- 2 Remove the Print Cartridge Set and the Belt Unit.



Memo

- Refer to "Maintenance Guide" for the procedure to install the print cartridge set and belt unit.

- 3 Confirm the sensor position.

Sensor Position Adjustment Dial



Position During Regular Usage
Factory setting is this position.

65 mm from edge of paper

58.5 mm from edge of paper

Edge of paper



The "|" indicates the gap sensor position

The "∇" indicates the black mark sensor position

(1) Check the black mark sensor position

Confirm the center of the black mark on the media and the black mark sensor position on the device (number on the ▽ indicator).

If the position of the black mark and the black mark sensor position do not align, rotate the Sensor Position Adjustment Dial to adjust the position (go to step 4).

The black mark sensor position is set, at the factory, to 58.5 mm from the right edge of the label liner.

Adjust the position of the "▽" so it is in the center of the black mark of the media you are using.

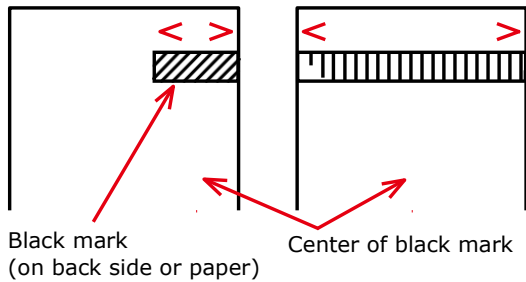

(2) Check the gap sensor position
Confirm the center of the label on the media and the gap sensor position on the device (number on the | indicator).

If the position of the label and the gap sensor position do not align, rotate the Sensor Position Adjustment Dial to adjust the position (go to step 4).

The gap sensor position is set, at the factory, to 65 mm from the right edge of the label liner.

Adjust the position of the " | " so it is in the center of the labels of the media you are using.

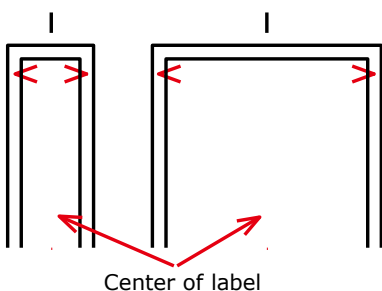

4 Rotate the Sensor Position Adjustment Dial to adjust the sensor position.

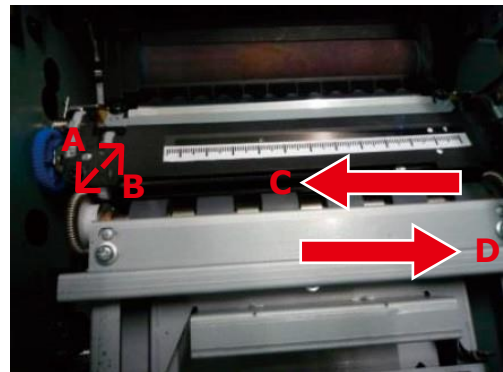

Memo

- If you rotate the Sensor Position Adjustment Dial in direction A→the sensor position moves in the direction C
direction B→the sensor position moves in the direction D

Sensor Calibration

1 Click [Start] and select [Control Panel] in [Windows System].

2 Click [View devices and printers].

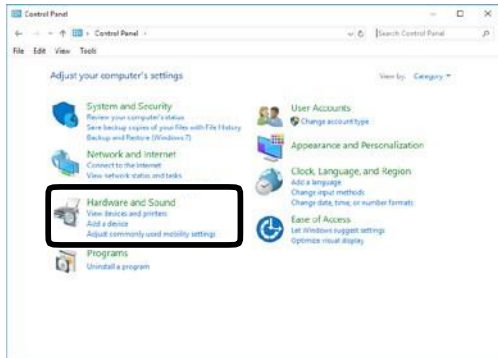

3 Right-click the [LT5C PCL6] icon, and then select [Printing preferences].

4 On the [Setup] tab, click [User-defined paper].

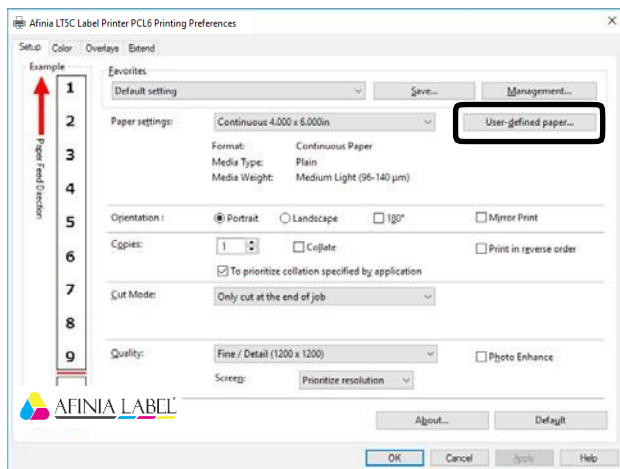

5 Input information about the paper you want to register. To adjust settings that are already registered, select the names of the paper from the list in [Registered user-defined paper].

6 Click [Sensor Adjustment].

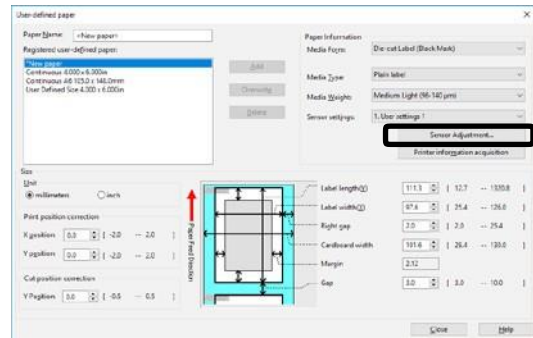

Memo

- [Sensor Adjustment] appears if the following conditions are met.
 - The Media Form is one of the following
Continuous Paper (Black Mark)
Die-cut Label (Gap)
Die-cut Label (Black Mark)
Continuous Label (Black Mark)
 - The [Ports] of the printer driver is USB or standard TCP/IP port
- Before performing [Sensor Adjustment], make sure that the printer is "online".
- If [Sensor Adjustment] does not appear, advance to step 12 of this procedure.

7 Click [Next].

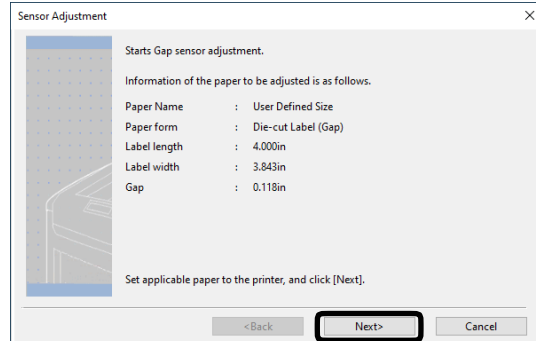

Memo

- Before performing the next steps of this procedure, make sure that paper is loaded.
- If there are no paper size settings configured on the control panel, it may cause a paper size mismatch on the device. Pressing the <OK> button on the control panel overwrites the device paper size setting with the paper size setting in the printer driver.

8 Select a registration location (a) for the adjustment, and then enter a registration name (b).

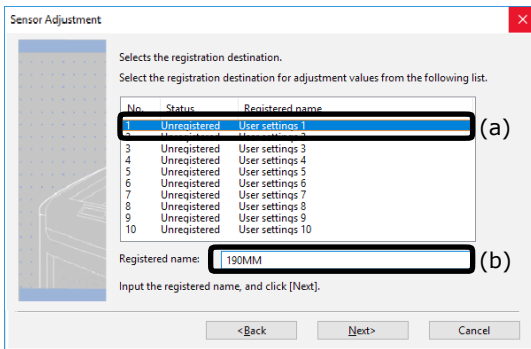

Memo

- You can enter up to eight alphanumeric English characters for the registration name.

9 Click [Next]. This starts the sensor adjustment and displays a wait message.

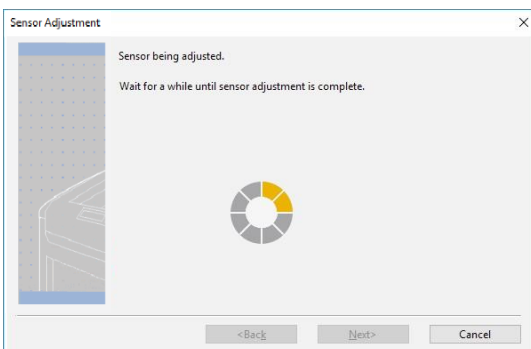
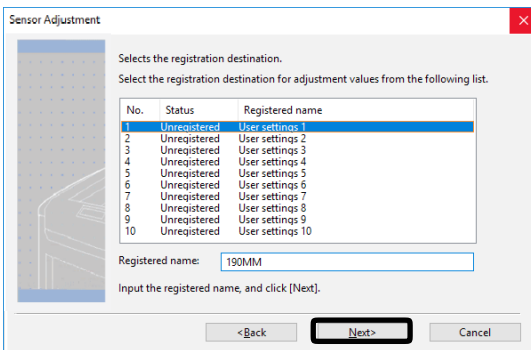

10 When the completion screen appears, click [Complete].

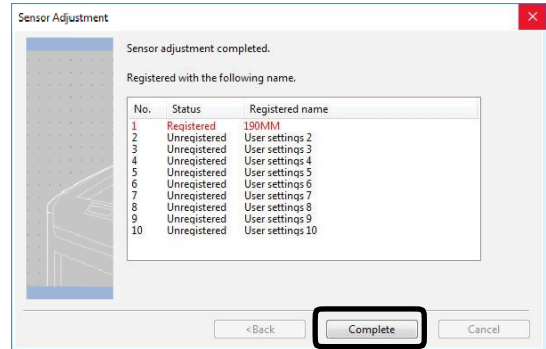

Memo

- The results of adjusting the sensor are registered on the printer. In [Sensor settings] in [User-defined paper] in the printer driver, you can specify the number registered in the printer for the adjustment results and whether to apply it when printing. By standardizing the registration numbers of the sensor adjustment results, you can get the same print results by specifying the same number in [Sensor settings] in the printer driver for any printer. This is useful when printing on the same media on multiple printers.

11

To register new settings, click [Add] or click [Overwrite] to select paper that is already registered.

12

Click [OK] or [Close] as many times as necessary to exit the "Printing preferences" screen.

13

Open the file to be printed.

14

Specify a registered paper size, and then print.

If You Cannot Set the Sensors from the Printer Driver

If you cannot set the sensors from the printer driver, then set them from the control panel.

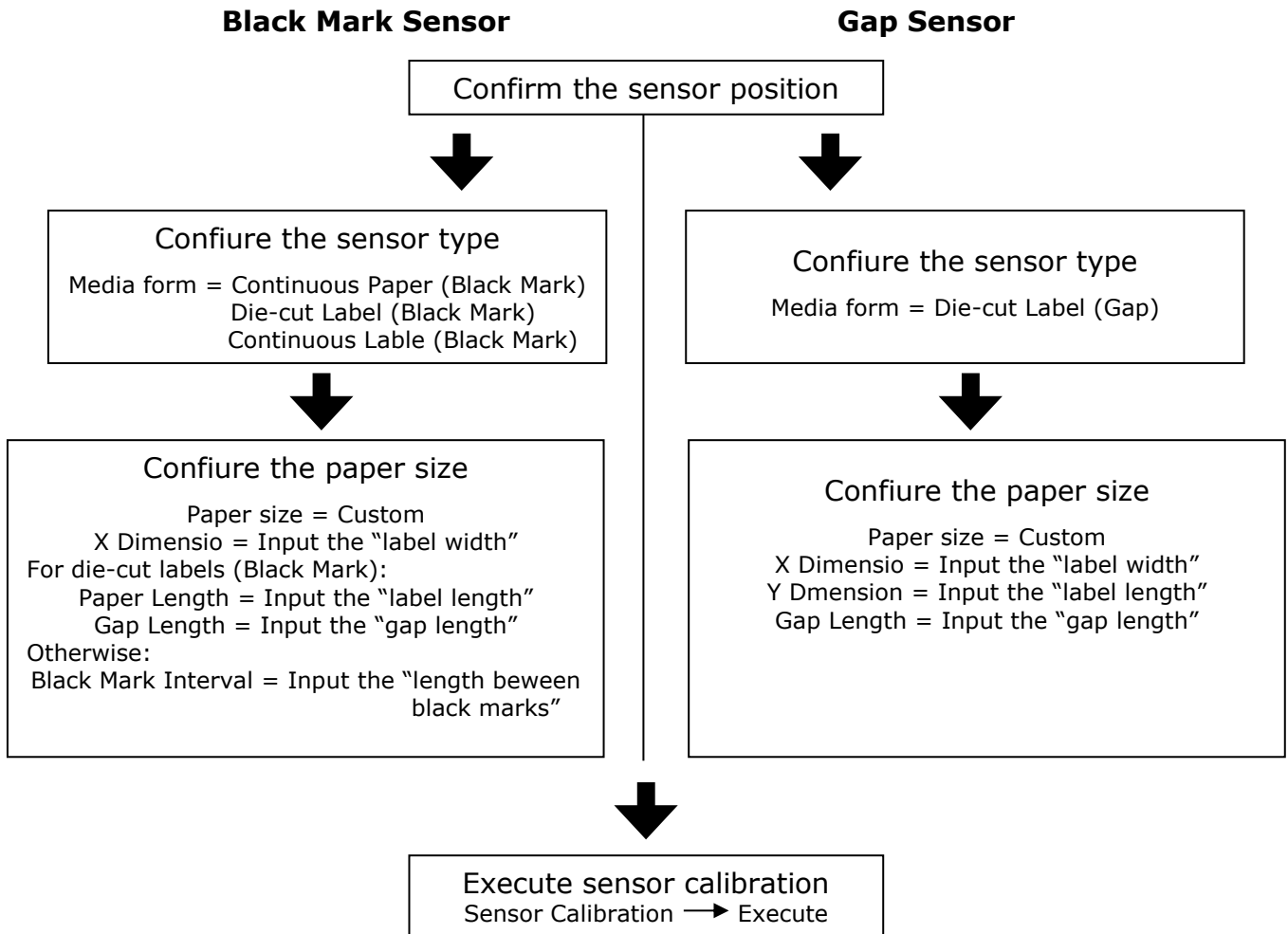

Calibrating the Black Mark Sensor

You can adjust the black marks on roll paper using the black mark sensor.

Here, we will show the method when Continuous Label (Black Mark) are used.

1 Press the <Fn> key.

The numerical values input screen will be displayed.

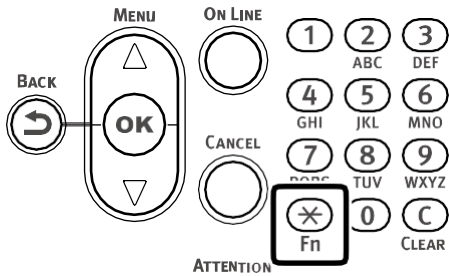

2 Press <8>, <9>, <1> (function numbers), and then press the <OK> button.

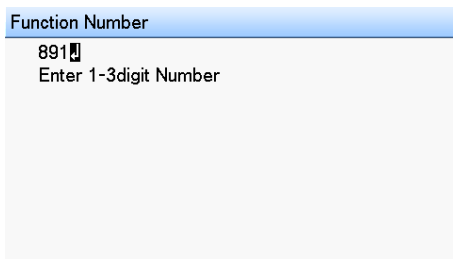

3 Select [6. Continuous Label (Black Mark)], and then press the <OK> button.

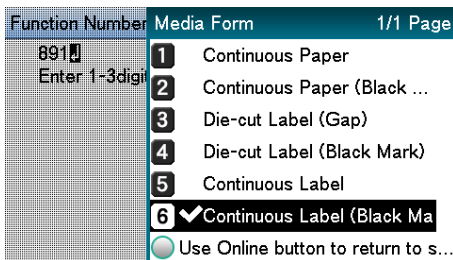

4 Press the <ON LINE> button to return to the standby screen.

5 Press the <Fn> key, and then press the following buttons: <9>, <0>, <OK>.

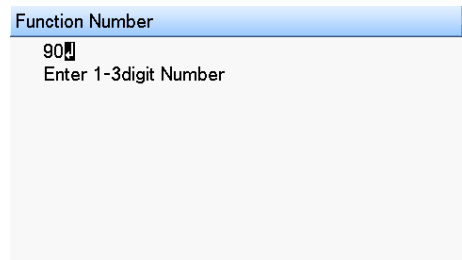

6 On the Paper Size menu, select [Custom], press the <OK> button, and then press the <ON LINE> button. The display will return to the standby screen.

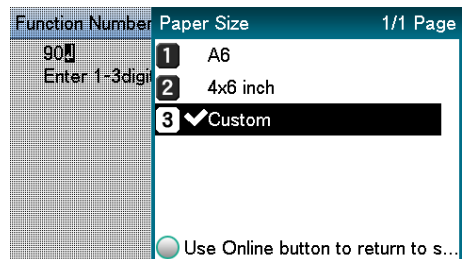

7 Press the <Fn> key, and then press the following buttons: <9>, <1>, <OK>.

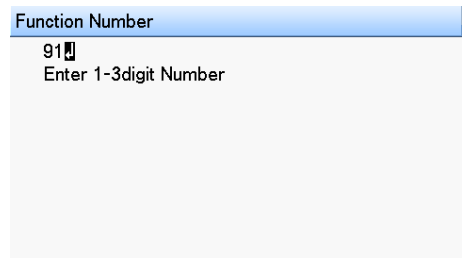

8 Use the numeric keypad to enter the label width, press the <OK> button, and then press the <ON LINE> button. The display will return to the standby screen.

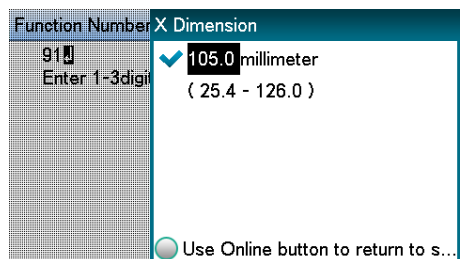

9 Press the <Fn> key, and then press the following buttons: <8>, <9>, <0>, <OK>.

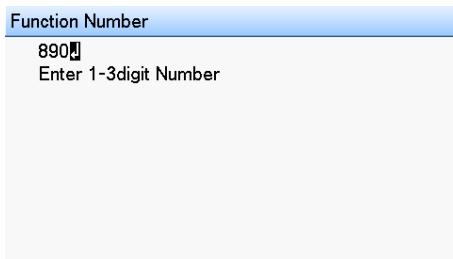

10 Select [Black Mark Interval] from [Unwinder Config], and then press the <OK> button.

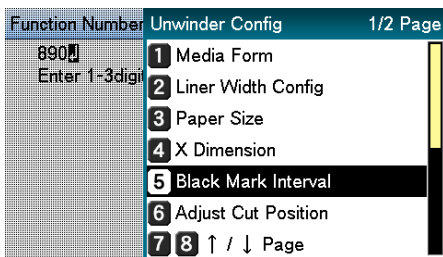

11 Use the numeric keypad to enter the Black Mark Interval, press the <OK> button, and then press the <ON LINE> button. The display will return to the standby screen.

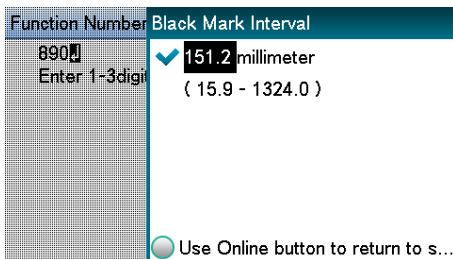

12 Press the <Fn> key, and then press the following buttons: <8>, <9>, <3>, <OK>.

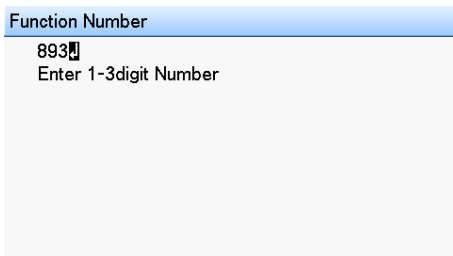

13 Select the setting number of the sensor to be configured, and then press the <OK> button.

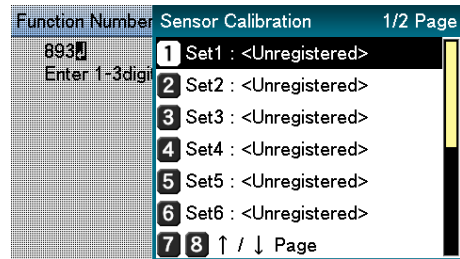

14 Select [Execute Calibration], and then press the <OK> button.

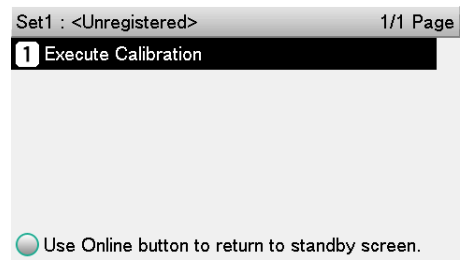

15 Enter the sensor calibration name, and then press the <OK> button.

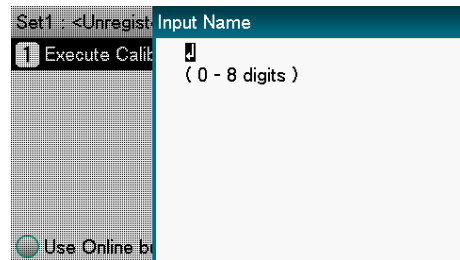

Memo

- You can leave the name blank, if you want.

16 If an execution confirmation screen appears, select [Yes].

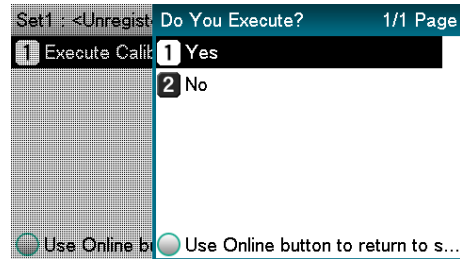

17 This executes sensor calibration.

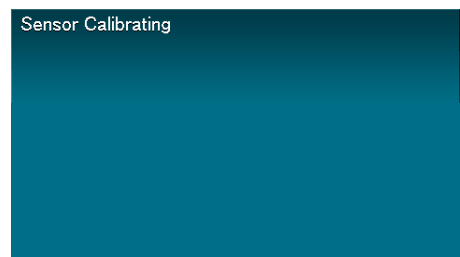

18 After sensor calibration is complete, press the <OK> button.

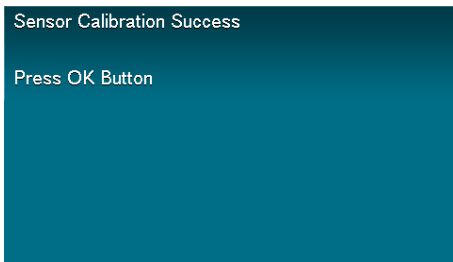

Calibrating the Gap Sensor

You can adjust the distance between die cut labels using the gap sensor.

1 Press the <Fn> key. The numerical values input screen will be displayed.

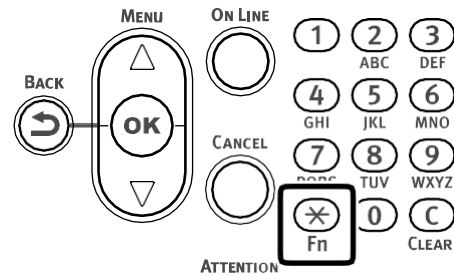

2 Press <8>, <9>, <1> (function numbers), and then press the <OK> button.

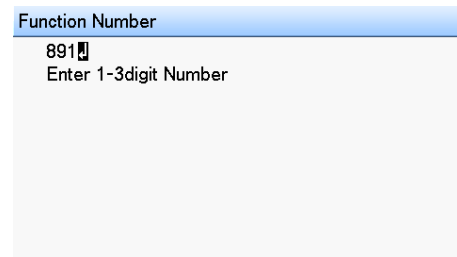

3 Select [3. Die-cut Label (Gap)], and then press the <OK> button.

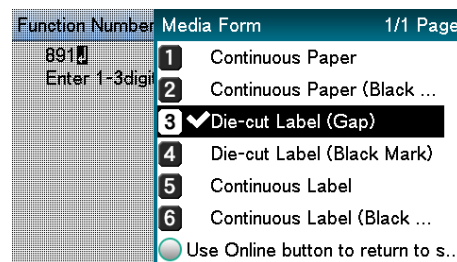

4 Press the <ON LINE> button to return to the standby screen.

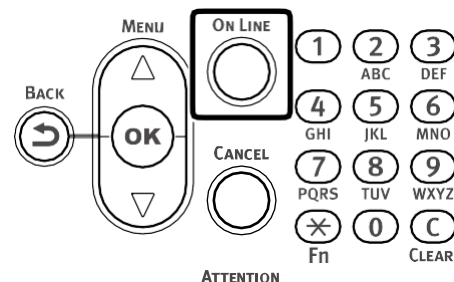

5 Press the <Fn> key, and then press the following buttons: <9>, <0>, <OK>.

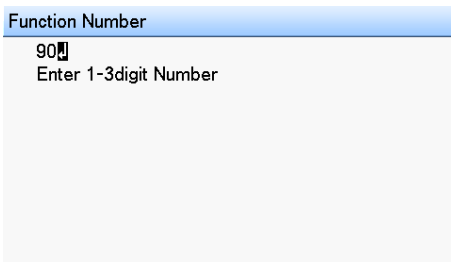

6 On the Paper Size menu, select [Custom], press the <OK> button, and then press the <ON LINE> button. The display will return to the standby screen.

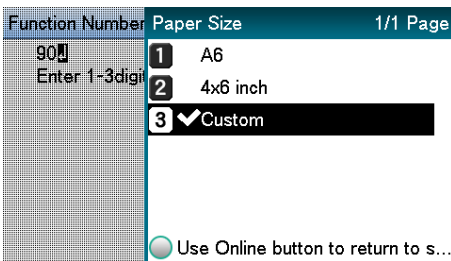

7 Press the <Fn> key, and then press the following buttons: <9>, <1>, <OK>.

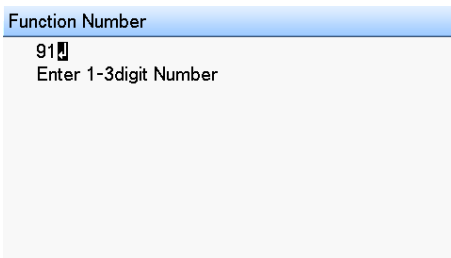

8 Use the numeric keypad to enter the label width, press the <OK> button, and then press the <ON LINE> button. The display will return to the standby screen.

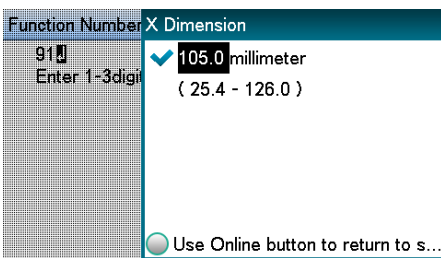

9 Press the <Fn> key, and then press the following buttons: <9>, <2>, <OK>.

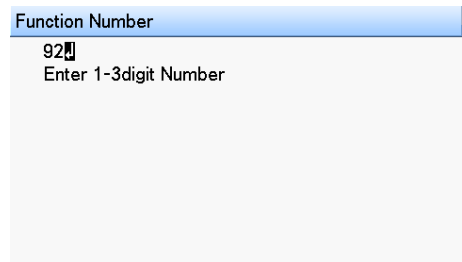

10 Use the numeric keypad to enter the label length, press the <OK> button, and then press the <ON LINE> button. The display will return to the standby screen.

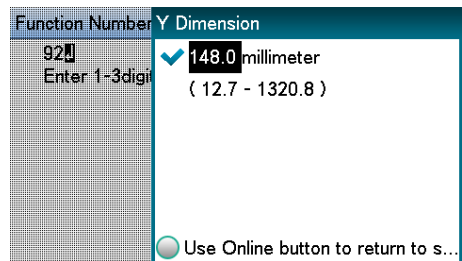

11 Press <8>, <9>, <0> (function numbers), and then press the <OK> button.

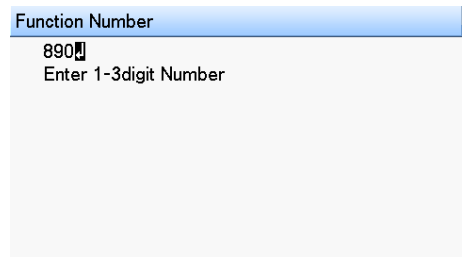

12 Select [Gap Length] from [Unwinder Config], and then press the <OK> button.

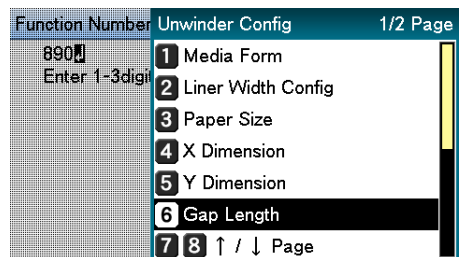

- 13** Use the numeric keypad to enter the gap length, press the <OK> button, and then press the <ON LINE> button. The display will return to the standby screen.

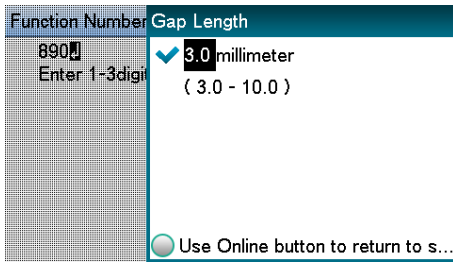

- 14** From here, perform the same steps as those under "Calibrating the Black Mark Sensor" from step 12 of this procedure.

□ Detecting the Interval between Pages

■ When executing from the printer driver

You can use the following procedure, from the printer driver, to register the paper gap and black mark interval on the device. Registering these settings improves your printing results. However, it does waste approx. 10 sheets of paper.

- 1 Click [Start] and select [Control Panel] in [Windows System].
- 2 Click [View devices and printers].
- 3 Right-click the [LT5C PCL6] icon, and then select [Printing preferences].
- 4 On the [Setup] tab, click [User-defined paper].
- 5 After confirming that the paper name you entered in the "Paper Name" box is shown under [Registered user-defined paper], click [Close].

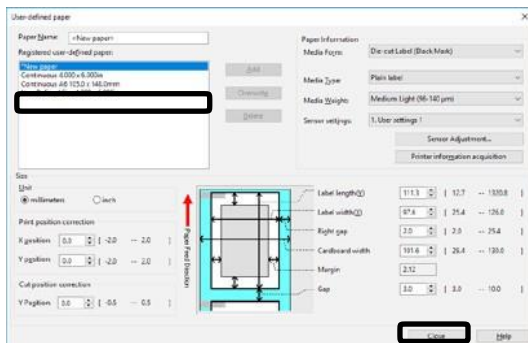

- 6 For [Paper settings], select the paper settings you registered, and then click [Paper interval detection].

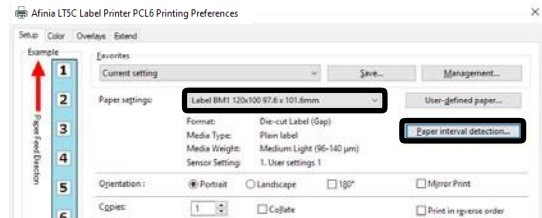

Memo

- [Paper interval detection] is displayed if the following conditions are met.
 - The Media Form is one of the following
Continuous Paper (Black Mark)
Die-cut Label (Gap)
Die-cut Label (Black Mark)
Continuous Label (Black Mark)
 - The [Ports] of the printer driver is USB or standard TCP/IP port
- If [Paper interval detection] does not appear, advance to step 8 of this procedure.

- 7 Confirm the displayed paper information, and then click [Measure].

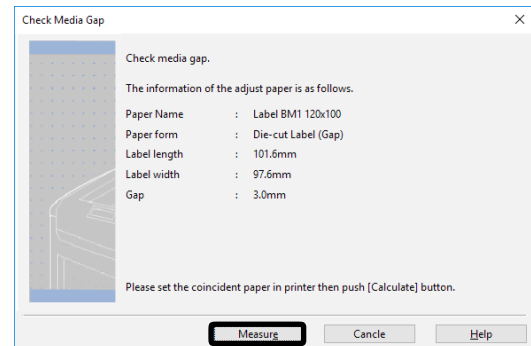

This starts checking the media pitch and closes the dialog box.

Memo

- If you change to another type of paper, you should execute this paper interval detection again.

- 8 Click [OK] as many times as necessary to exit the "Printing preferences" screen.

- 9 Open the file to be printed.

- 10 Specify a registered paper size, and then print.

■ When executing from the control panel

Detect the paper gap and black mark interval from the control panel.

1 For black mark media, execute steps 1 to 11 in "Calibrating the Black Mark Sensor" (P.38).

For gap media, execute steps 1 to 13 in "Calibrating the Gap Sensor" (P.40).

2 Press the <Fn> key.

3 Press <8>, <9>, <4> (function numbers) and then press the <OK> button.

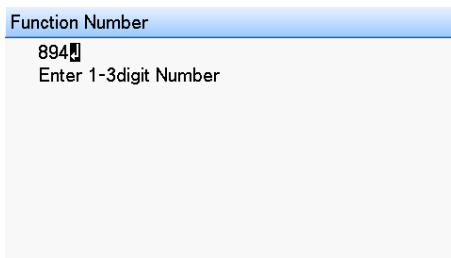

4 Select [Execute], and then press the <OK> button to start paper interval detection and close the dialog box.

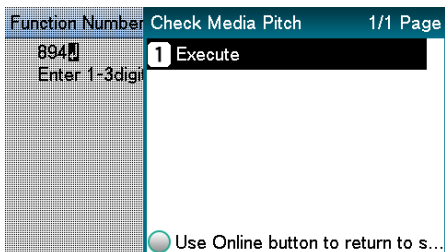

□ Printing

After loading the paper, use the computer to open the file you want to print. Next, use the printer driver to select the [Paper Size] and [Paper Weight], and then print.

Memo

- When printing on label paper for the first time, execute [Sensor Adjustment] before printing.
- When reprinting after an error occurs, if Cut Mode is set, the media may not be cut in the position you expect. If you want to align the cut positions, temporarily cancel printing, and then send the print data starting from the page you want to reprint.

Reference

- For detailed explanations of the printer driver setup items, see "Online Help".
- For information about how to load paper, see "Loading Media" (P.24).

■ Windows PCL Printer Driver

Here, we will show how to print an open WordPad file as an example.

- 1 Select [Page Setup] in the [File] menu.
- 2 Select the paper size and print orientation, and then click [OK].
- 3 On the [File] menu, click [Print] > [Print].
- 4 Click [Preferences].
- 5 On the [Setup] tab, configure [Paper settings].

7 Click [Print] in the "Print" screen to print.

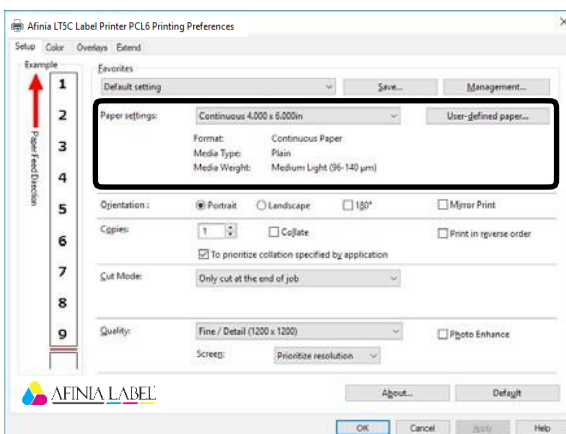

Memo

- Configure the [Cut Mode] setting on the [Setup] tab as required.

6 When the settings are complete, click [OK] in the "Setup" screen.

□ Canceling a Print Job

Use the procedure below to cancel a print job from the printer's control panel.

- 1 On the control panel, press the <CANCEL> button.

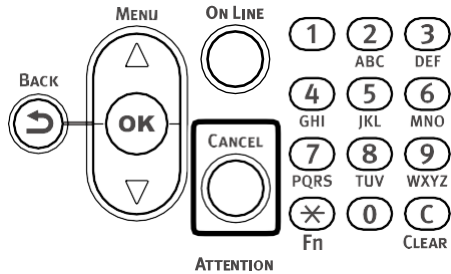

- 2 If a verification message appears, select [Yes], and then press the <OK> button.

3

Print Function Settings

Printer Driver Functions Table.....	48
Table of Setting Items in the Control Panel Menu Screen ...	50
Saving Toner When Printing.....	79
Fine Quality Printing	81
Adjusting the Print Position on the Paper	84
Other Print Functions	87
Deleting or Updating a Printer Driver	98

 **Note**

- The examples in this chapter use Windows WordPad for explanations. Depending on the application, the screens and operations procedures may differ.
- For detailed explanations of the printer driver and utility setup items, see "Online Help".
- Due to printer driver and utility version upgrades, actual operations may be different from the descriptions in this manual.

Printer Driver Functions Table

This section explains the convenient functions when printing from a PC.



- For detailed explanations of the printer driver setup items, see "Online Help".

Explanation of Functions

Windows PCL Printer Driver Functions

[Setup] Tab

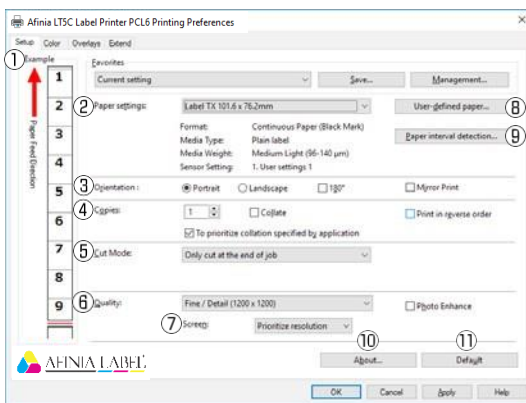

[User-defined paper]

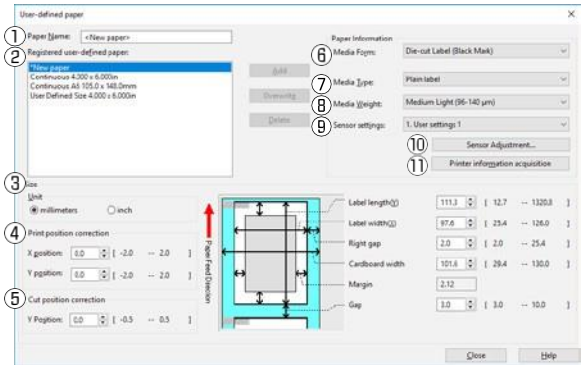

Item	Description
① Example	Shows what printing results will be based on current settings. This example is just an approximation and does not indicate the exact actual number of print pages and cut positions.
② Paper settings	Specifies, from among registered paper settings, which one should be applied for printing.
③ Orientation	Specifies the print orientation.
④ Copies	Specifies the quantity to be printed.
⑤ Cut Mode	Specifies the timing to cut roll paper when cutting and printing on it.
⑥ Quality	Specifies the resolution during printing.
⑦ Screen	Specifies the halftoning available with the device.
⑧ User-defined paper	Click when using the driver to register paper settings to be used for printing.
⑨ Paper interval detection	Before printing to black mark or die-cut labels, click to execute learning on the device to improve the print position before starting. Note that executing this function will cause some paper to be used.
⑩ About	Displays the printer driver version information.
⑪ Default	Restores default settings.

Item	Description
① Paper Name	Enter the name of the paper settings you want to register.
② Registered user-defined paper	Shows a list of paper settings that have been registered.
③ Size	Specifies either millimeters or inches as the unit for input values.
④ Print position correction	Adjusts the print start position on the paper edge.
⑤ Cut position correction	Adjusts the cut position when cutting and printing roll paper.
⑥ Media Form	Specifies the paper setting type to be registered. Size input items change in accordance with this setting.
⑦ Media Type	Specifies the paper type.
⑧ Media Weight	Specifies the paper thickness.
⑨ Sensor settings	Specifies the settings, from among those registered on the device, to be used for printing.
⑩ Sensor Adjustment	Click to calibrate the gap of black mark or die-cut labels, and register the results as device sensor settings. This button is not displayed for media forms that do not require calibration.
⑪ Printer information acquisition	Obtains, from devices, the names of settings registered as sensor settings and the names of user types registered as paper types, and reflects them in the sensor settings and paper type list on the printer driver.

[Color] Tab

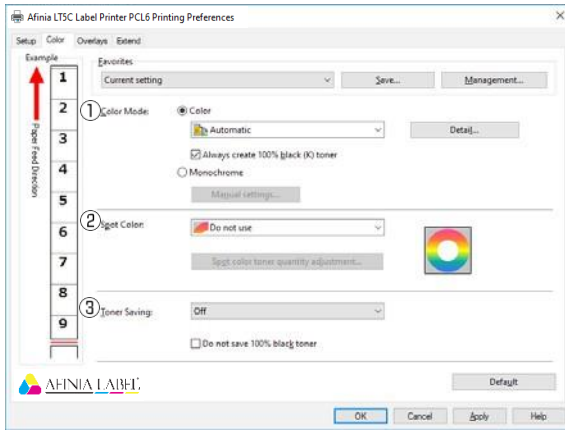

	Item	Description
①	Color Mode	Selects either color printing or monochrome printing. When color is selected, clicking [Detail] displays the "Detail" dialog box, which can be used to configure detailed color printing settings.
②	Spot Color	Specifies how white toner should be used for printing.
③	Toner Saving	Specifies the print density when economizing on toner.

[Extend] Tab

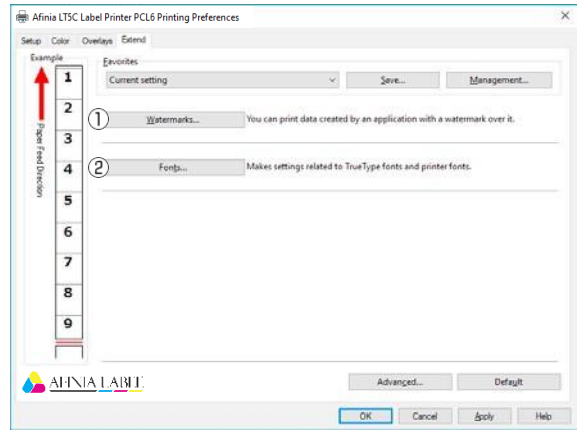

	Item	Description
①	Watermarks	Sets when implementing stamp printing.
②	Fonts	Configures TrueType and printer font settings.

[Overlays] Tab

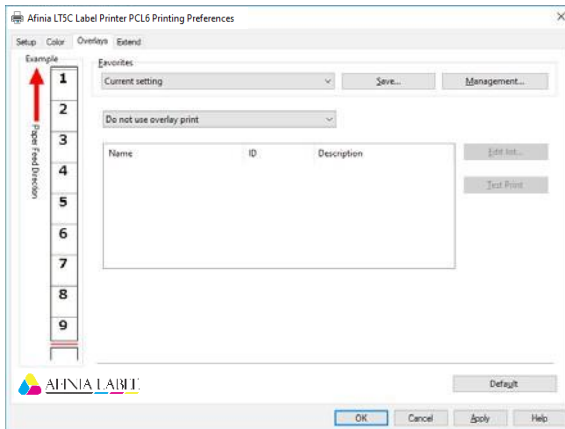

	Item	Description
	Overlays	Specifies whether or not a form should be overlaid on the document to be printed, or whether the document should be registered as a new form in the device.

□ Table of Setting Items in the Control Panel Menu Screen

Device Setup Screen

Item	Description
Configuration	View device information (total number of sheets, remaining consumable quantity, system information, etc.)
Print Information	Print the settings, usage report, error log, color profile list, and user media lists for this machine.
Menus	Used to configure system settings, print position adjustment, color, and other settings.
Admin Setup	Administrator sets the network settings, changes passwords, etc.
Print Statistics	Check the print use status of the user.
Calibration	Used to adjust the color densities and shades, color misalignment, etc.
Boot Menu	Set whether or not to restart the printer when a malfunction occurs in the HDD or file system, etc.

[Configuration]

Item			Description
Feeder Count	Unwinder	nnnnnn	Displays the total print quantity for the unwinder. (This is the number of sheets converted into the A6 size paper from the length of paper fed from the unwinder.)
Supplies Life	Cyan Print Cartridge	Remaining nnn%	Shows the remaining service life (%) of each color's print cartridge.
	Magenta Print Cartridge	Remaining nnn%	
	Yellow Print Cartridge	Remaining nnn%	
	Black Print Cartridge	Remaining nnn%	
	White Print Cartridge	Remaining nnn%	
	Waste Toner Box	Remaining nnn%	Shows the remaining service life (%) of the waste toner box.
	Belt	Remaining nnn%	Shows the remaining service life (%) of the belt unit.
	Fuser	Remaining nnn%	Shows the remaining service life (%) of the fuser unit.

Item		Description	
Network	Printer Name	***** ***** *****	Shows the printer name used by the DNS and Network PnP.
	Short Printer Name	***** *****	Displays the short printer name.
	IPv4 Address	xxx.xxx.xxx. xxx	Shows the IP address. When TCP/IP is enabled, shows the setup of the following control panel setting [Admin Setup] > [Network Setup] > [IPv4 Address].
	Subnet Mask	xxx.xxx.xxx. xxx	Displays the subnet mask. When TCP/IP is enabled, shows the setup of the following control panel setting [Admin Setup] > [Network Setup] > [Subnet Mask].
	Gateway Address	xxx.xxx.xxx. xxx	Displays the gateway address. When TCP/IP is enabled, shows the setup of the following control panel setting [Admin Setup] > [Network Setup] > [Gateway Address].
	MAC Address	xx:xx:xx: xx:xx:xx	Shows the MAC address.
	Network FW Version	xx.xx	Shows the network firmware version.
	Web Remote Version	xx.xx	Shows the web page version.
	IPv6 Address (Local)	xxxx:xxxx:xx xx:xxxx:xxxx :xxxx:xxxx:x xxx	Shows the (local) IPv6 address. This menu is not displayed when TCP/IP is disabled or when the IP version is IPv4.
	IPv6 Address (Global)	xxxx:xxxx:xx xx:xxxx:xxxx :xxxx:xxxx:x xxx	Shows the (global) IPv6 address. This menu is not displayed when TCP/IP is disabled or when the IP version is IPv4.
System	Serial Number	xxxxxxxxxx xxxxxxxxxx xxxxxx	Displays the serial number.
	Asset Number	xxxxxxxxxx xxxxxxxxxx xxxxxxxxxxxx	Displays the asset number of the printer manager.
	Firmware Version	xxx.xx_x_x	Shows the version number of FirmSuite.
	CU Version	xx.xx	Displays the control unit firmware version.
	PU Version	xx.xx.xx	Displays the printer unit firmware version.
	RAM	xxMB	Shows the total availability of all mounted RAM.
	Flash Memory	xxMB[Fxx]	Displays the total availability of all flash memory and flash system versions installed.
	HDD	xx.xxGB [Fxx]	Displays the HDD size and file system version installed.
Date and Time	mm/dd/yyyy or dd/mm/yyyy	Displays the current date and time.	

[Print Information]

Item			Description
Configuration		Execute	Prints the device setup details.
Demo Page	DEMO1	Execute	Prints the demo pages.
File List		Execute	Prints the file list.
Usage Report ^{*1}		Execute	Prints the total print results.
Error Log		Execute	Prints the error log.
Color Profile List		Execute	Prints the color profile list.
User Media List ^{*2}		Execute	Prints the user media list.
Test Print-1		Execute	Prints the patterns for analyzing the print quality.
Test Print-2		Execute	Prints the patterns for analyzing the CMYK print quality.
Test Print-3		Execute	Prints the patterns for analyzing the status of the print cartridges.
Test Print-4		Execute	Prints the patterns for analyzing print quality of the spot colors.
Cleaning Page		Execute	Prints the toner-free white sheet to remove dirt from the surface of the fuser belt in the fuser unit.

*1: Not displayed if [Disable] is set for the control panel [Print Statistics] > [Usage Report] item.

*2: Displayed when the user media is registered.

[Menus]**■ Unwinder Config**

- Shaded areas are factory-set values.

Item	Value	Description	
Media Form	Continuous Paper Continuous Paper (Black Mark) Die-cut Label (Gap) Die-cut Label (Black Mark) Continuous Label Continuous Label (Black Mark)	Specifies the shape of the roll paper.	
Liner Width Config	Liner Width Mode	Auto Custom	Specifies the mode for setting the width of the label's liner. Auto: The width of the liner is set given that the label is in the center of the liner. Custom: The width of the liner is input and the left gap is calculated given that the left and right gaps are different.
	Liner Width	29.4 millimeter (1.16 inch) ⌋ 105.6 millimeter (4.16 inch) 109.0 millimeter (4.29 inch) ⌋ 130.0 millimeter (5.12 inch)	Inputs the width of the liner. Appears when the [Liner Width Mode] is [Custom]. The initial values vary depending on your operating environment.
	Right Gap	2.0 millimeter (0.08 inch) ⌋ 25.4 millimeter (1.00 inch)	Specifies the distance from the right edge of the label to the right edge of the liner.
Paper Size	A6 4x6 inch Custom	Sets the size of the paper for the unwinder. The initial values vary depending on your operating environment.	
X Dimension	25.4 millimeter (1.00 inch) ⌋ 101.6 millimeter (4.00 inch) 105.0 millimeter (4.13 inch) ⌋ 126.0 millimeter (4.96 inch) ^{*1}	Sets the width of the custom paper sizes for the unwinder. Sets the dimension perpendicular to the paper feed direction. The initial values vary depending on your operating environment.	

*1: 130.0 mm (5.12 inch) if the [Media Form] is [Continuous Paper] or [Continuous Paper (Black Mark)]

⌘ Shaded areas are factory-set values.

Item	Value	Description
Y Dimension	12.7 millimeter (0.50 inch) ↓ 101.6 millimeter (4.00 inch) ↓ 148.0 millimeter (5.83 inch) 152.4 millimeter (6.00 inch) ↓ 1320.8 millimeter (52.00 inch)	Sets the length of the custom paper sizes for the unwinder. Sets the same direction as for the dimension in the paper feed direction. If the setting is 101.6 mm (4.00 inch) or lower, then the set page length is handled as a whole-number multiple of the actual length of the page such that it exceeds 101.6 mm (4.00 inch). The initial values vary depending on your operating environment. Appears when the Media Form is [Continuous Paper], [Die-cut Label (Gap)], [Die-cut Label (Black Mark)] or [Continuous Label].
Black Mark Interval	15.9 millimeter (0.63 inch) ↓ 101.6 millimeter (4.00 inch) ↓ 151.2 millimeter (5.95 inch) 155.6 millimeter (6.13 inch) ↓ 1324.0 millimeter (52.13 inch)	Sets the interval of the marks on custom paper for the unwinder. Sets the same direction as for the dimension in the paper feed direction. If the setting is 104.8 mm (4.13 inch) or lower, then the set page length is handled as a whole-number multiple of the actual length of the page such that it exceeds 101.6 mm (4.00 inch). The initial values vary depending on your operating environment. Appears when the Media Form is [Continuous Paper (Black Mark)] or [Continuous Label (Black Mark)].
Gap Length	3.0 millimeter (0.12 inch) ↓ 10.0 millimeter (0.39 inch)	Sets the interval for labels. Sets the same direction as for the dimension in the paper feed direction. Appears when the Media Form is [Die-cut Label (Gap)] or [Die-cut Label (Black Mark)].
Adjust Cut Position	-0.5 millimeter (-0.02 inch) ↓ 0.0 millimeter (0.00 inch) ↓ +0.5 millimeter (+0.02 inch)	Specifies the compensation value for the distance from the print completion position to the cut position (beginning of next label). (Specifies margin on following edge) If you specify a negative value, cutting is done at a short position.

⌘ Shaded areas are factory-set values.

Item	Value	Description
Media Type	Plain Plain Labels Glossy Labels Film Labels1 Film Labels2 Film1 Film2 USERTYPE1*1 USERTYPE2*1 USERTYPE3*1 USERTYPE4*1 USERTYPE5*1 USERTYPE6*1 USERTYPE7*1 USERTYPE8*1 USERTYPE9*1 USERTYPE10*1 USERTYPE11*1 USERTYPE12*1 USERTYPE13*1 USERTYPE14*1 USERTYPE15*1 USERTYPE16*1 USERTYPE17*1 USERTYPE18*1 USERTYPE19*1 USERTYPE20*1	Sets the type of the paper for the unwinder.
Media Weight	Light Medium Light Medium Medium Heavy Heavy Ultra Heavy1 Ultra Heavy2 Ultra Heavy3	Sets the thickness of the paper for the unwinder.
Sensor Setting	Set1 : Set2 : Set3 : Set4 : Set5 : Set6 : Set7 : Set8 : Set9 : Set10 :	Sets the sensitivity of the gap sensor or black mark sensor. Only the adjusted sensor setting is displayed. Appears when the [Media Form] is something other than [Continuous Paper] or [Continuous Label].

*1: USERTYPE 1 to 20 are displayed when they are registered.

Table of Setting Items in the Control Panel Menu Screen

Item		Value	Description
Sensor Calibration	Set1 : Execute Calibration	Execute	Executes calibration of the gap sensor or black mark sensor.
	Set2 :		
	Set3 : <u>Adjust Reflective</u>	0	Fine tunes the sensitivity of the reflective sensor in the unwinder that was measured during Sensor Calibration.
	Set4 : <u>Slice Sensor in</u>		
	Set5 : <u>Level Unwinder</u>	1023	The default value fluctuates according to the results of the calibration. Appears when the black mark sensor is used.
	Set6 :		
	Set7 :		
	Set8 :		
	Set9 :		
	Set10 : <u>Reflective Sensor in Printer</u>	0	Fine tunes the sensitivity of the reflective sensor in the device that was measured during Sensor Calibration. The default value fluctuates according to the results of the calibration. Appears when the black mark sensor is used.
	<u>Transmission Sensor in Unwinder</u>	0	Fine tunes the sensitivity of the transmission sensor in the unwinder that was measured during Sensor Calibration. The default value fluctuates according to the results of the calibration. Appears when the gap sensor is used.
	<u>Transmission Sensor in Printer</u>	0	Fine tunes the sensitivity of the transmission sensor in the device that was measured during Sensor Calibration. The default value fluctuates according to the results of the calibration. Appears when the gap sensor is used.
	<u>Change Name</u>	Execute	You can change the name of the specified setting numbers. You can use up to eight characters of single-byte upper case English and numbers.
	<u>Reset Setting</u>	Execute	Initializes the content of the specified setting numbers.
Check Media	Pitch	Execute	Measures the intervals on the paper. Appears when the [Media Form] is something other than [Continuous Paper] or [Continuous Label].

■ Cutter Setup

• Shaded areas are factory-set values.

Item	Value	Description
Cut Mode	Job Collation Specified Interval	Specifies the cutting operation. Job: Cuts at the end of a job. Collation: Cuts at the end of the job and at the end of the job collation. Specified Interval: Cuts in units of the specified number of pages. Cuts at the end of the collation/job.
Cut Interval	1 9999	Sets how many pages are cut each time. Appears when the [Cut Mode] is [Specified Interval].

■ System Adjust

• Shaded areas are factory-set values.

Item	Value	Description
Power Save Time	1 minute 2 minutes 3 minutes 4 minutes 5 minutes 10 minutes 15 minutes 30 minutes 60 minutes	Sets the time until the printer enters power save mode.
Auto Power Off Time	1 hour 2 hours 3 hours 4 hours 8 hours 12 hours 18 hours 24 hours	Sets the time until the printer enters OFF mode from stand-by status.
Clearable Warning	ONLINE Job	Sets the timing until clearable warning display turns OFF.
Timeout InJob	Off 5 seconds 10 seconds 20 seconds 30 seconds 40 seconds 50 seconds 60 seconds 90 seconds 120 seconds 150 seconds 180 seconds 210 seconds 240 seconds 270 seconds 300 seconds	Sets the time from loss of the receipt of data until force-printing. With PS, the job is canceled without printing.
Timeout Local	0 seconds 5 seconds 40 seconds 290 seconds 295 seconds 300 seconds	Sets the time for each port to be kept opened after printing. (Excludes network)
Timeout Network	0 seconds 5 seconds 90 seconds 290 seconds 295 seconds 300 seconds	Sets the time for the network port to be kept opened after printing.
Error Report	On Off	Specifies whether to print error reports when an internal PCL or PS error occurs.
Hex Dump	Execute	Prints received data in QR code. Turn off the power to stop printing the hex dump.

■ Print Adjust

• Shaded areas are factory-set values.

Item		Value	Description
Print Position Adjust	X Adjust	0.00 millimeters +0.1 millimeters ⌋ +2.00 millimeters -2.00 millimeters ⌋ -0.1 millimeters	Adjusts the overall image print position perpendicularly (horizontally) in the direction of paper feed (0.1 mm intervals).
	Y Adjust	0.00 millimeters +0.1 millimeters +2.00 millimeters -2.00 millimeters -0.1 millimeters	Adjusts the overall image print position in the direction of paper feed (vertically) (0.1 mm intervals).
Paper Edge Detect Mode		Mode1 Mode2 Off	Set the action of the controls for the leading edge of the media to avoid image skew and detection position skew of the leading edge of labels. Mode1: For long leading edges, this setting automatically cuts/ outputs and then starts printing. For short leading edges, printing just starts. (Applicable for the gap/ black mark setting) Mode2: For short or long leading edges, this setting automatically cuts/outputs and then starts printing for both situations. (Applicable for the gap/black mark setting if the leading edge is long. If the leading edge is short, then only the gap setting is applicable.) Off: With this mode, the user straightens the leading edge so paper is not wasted. (Applicable for the gap/black mark setting)
Roll Paper End Detect Mode		Auto Stop Forced Cut	Sets the control for ejecting the trailing edge of the paper to auto, stop feeding, or forced cut. Auto: With this mode, the trailing edge is processed appropriately according to the media. Stop: With this mode, feed is forced to stop when the trailing edge of the paper is detected, regardless of the length or type of media. Forced Cut: With this mode, the system is forced to cut and eject the paper when the trailing edge of the paper is detected, regardless of the length or type of media.
Media Transfer Setting Black		0 +1 +2 +3 -3 -2 -1	Performs fine adjustment if black is faded or tiny white spots appear when printing with the black (K) print cartridge only (when printing with the YMCW print cartridges are raised). Lower the setting value if there are only fewer white spots, or raise the setting value if the high-density portion is thinner.
Media Transfer Setting Color		0 +1 +2 +3 -3 -2 -1	Performs fine adjustment if colors are faded or tiny white spots appear when printing with two or more print cartridges or just the white (W) print cartridge. Lower the setting value if there are only fewer white spots, or raise the setting value if the high-density portion is thinner.

Table of Setting Items in the Control Panel Menu Screen

⌘ Shaded areas are factory-set values.

Item		Value	Description
SMR Setting	Cyan	0	Compensates for uneven print density due to temperature and humidity, and printing quantity, using cyan. Raise the setting value if it is blurred. Lower the setting value if the density darkens partially. * Continued use with the setting value raised has a risk of printing stains. * Continued use with the setting value lowered has a risk of blurring.
		?	
		+3	
		-6	
		-1	
	Magenta	0	Compensates for uneven print density due to temperature and humidity, and printing quantity, using magenta. Raise the setting value if it is blurred. Lower the setting value if the density darkens partially. * Continued use with the setting value raised has a risk of printing stains. * Continued use with the setting value lowered has a risk of blurring.
		?	
		+3	
		-6	
		-1	
	Yellow	0	Compensates for uneven print density due to temperature and humidity, and printing quantity, using yellow. Raise the setting value if it is blurred. Lower the setting value if the density darkens partially. * Continued use with the setting value raised has a risk of printing stains. * Continued use with the setting value lowered has a risk of blurring.
		?	
		+3	
		-6	
		-1	
	Black	0	Compensates for uneven print density due to temperature and humidity, and printing quantity, using black. Raise the setting value if it is blurred. Lower the setting value if the density darkens partially. * Continued use with the setting value raised has a risk of printing stains. * Continued use with the setting value lowered has a risk of blurring.
		?	
		+3	
		-6	
		-1	
	White	0	Compensates for uneven print density due to temperature and humidity, and printing quantity, using white. Raise the setting value if it is blurred. Lower the setting value if the density darkens partially. * Continued use with the setting value raised has a risk of printing stains. * Continued use with the setting value lowered has a risk of blurring.
		?	
		+3	
		-6	
		-1	

⌘ Shaded areas are factory-set values.

Item		Value	Description
BG Setting	Cyan	0	Compensates for print results variation due to differences in the temperature and humidity, using cyan. Lower the setting value if the underlay is dark. * Continued use with the setting value lowered has a risk of printing stains.
		+1	
		+2	
		+3	
		-3	
		-2	
	-1		
	Magenta	0	Compensates for print results variation due to differences in the temperature and humidity, using magenta. Lower the setting value if the underlay is dark. * Continued use with the setting value lowered has a risk of printing stains.
		+1	
		+2	
		+3	
		-3	
		-2	
	-1		
	Yellow	0	Compensates for print results variation due to differences in the temperature and humidity, using yellow. Lower the setting value if the underlay is dark. * Continued use with the setting value lowered has a risk of printing stains.
		+1	
		+2	
		+3	
		-3	
		-2	
-1			
Black	0	Compensates for print results variation due to differences in the temperature and humidity, using black. Lower the setting value if the underlay is dark. * Continued use with the setting value lowered has a risk of printing stains.	
	+1		
	+2		
	+3		
	-3		
	-2		
-1			
White	0	Compensates for print results variation due to differences in the temperature and humidity, using white. Lower the setting value if the underlay is dark. * Continued use with the setting value lowered has a risk of printing stains.	
	+1		
	+2		
	+3		
	-3		
	-2		
-1			
Drum Cleaning		On	Sets whether to implement drum cleaning before printing. The image quality may be improved.
		Off	
Transfer Roller Cleaning		Execute	Implements cleaning of the 2nd transfer roller unit.

⌘ Shaded areas are factory-set values.

Item		Value	Description
Transfer Setting	Cyan Transfer Setting	0	Lower the setting value if lateral-stripe white dots and dark streaks appear for cyan, green and blue toner. Raise the setting value if the high-density portion of cyan, green and blue is thinner.
		+1	
		+2	
		+3	
		-3	
		-2	
	Magenta Transfer Setting	0	Lower the setting value if lateral-stripe white dots and dark streaks appear for magenta and/or red toner. Raise the setting value if the high-density portion of magenta and/or red is thinner.
		+1	
		+2	
		+3	
		-3	
		-2	
	Yellow Transfer Setting	0	Lower the setting value if lateral-stripe white dots and dark streaks appear for yellow toner. Raise the setting value if the high-density portion of yellow is thinner.
		+1	
		+2	
		+3	
		-3	
		-2	
	Black Transfer Setting	0	Lower the setting value if lateral-stripe white dots and dark streaks appear for black toner. Raise the setting value if the high-density portion of black is thinner.
		+1	
+2			
+3			
-3			
-2			
White Transfer Setting	0	Lower the setting value if lateral-stripe white dots and dark streaks appear for white toner. Raise the setting value if the high-density portion of white is thinner.	
	+1		
	+2		
	+3		
	-3		
	-2		
DV Roller Cleaning 1	On	Adjust the toner disposal threshold. On: Image quality priority Off: Toner life priority	
	Off		
DV Roller Cleaning 2	Mode 1	May be effective against lateral striping caused by variations in ambient temperature and/or humidity. Try mode 2 if desired results are not produced by mode 1.	
	Mode 2		
	Off		

[Admin Setup]



Note

- To enter this menu, it is necessary to enter the [Password].
- The factory default setting of the administrator password is [999999].

■ Network Setup

- Shaded areas are factory-set values.

Item	Value	Description
TCP/IP	Enable Disable	Enables/disables TCP/IP protocols.
NetBIOS over TCP ^{*1}	Enable Disable	Enables/disables NetBIOS over TCP/IP.
IP Address Set ^{*1}	Auto Manual	Specifies whether to request the IP address from the DHCP server.
IPv4 Address ^{*1 *2}	xxx.xxx.xxx. xxx	Sets the IP address.
Subnet Mask ^{*1 *2}	xxx.xxx.xxx. xxx	Sets the subnet mask.
Gateway Address ^{*1 *2}	xxx.xxx.xxx. xxx	Sets the gateway address.
Web ^{*1}	Enable Disable	Enables/disables access using web browsers.
Telnet ^{*1}	Enable Disable	Enables/disables access using Telnet.
FTP ^{*1}	Enable Disable	Enables/disables access using FTP.
IPSec ^{*1}	Enable Disable	Enables/disables access using IPsec.
SNMP ^{*1}	Enable Disable	Enables/disables access using SNMP.
Network Scale	Normal Small	Normal: Printer operates effectively even if connected to a hub with spanning tree functions. However, printer startup time becomes longer when two or three computers are connected to a small-scale LAN. Small: Covers small scale LANs with 2 or 3 PCs to large scale LANs are covered, but if connected to a hub with spanning tree functions, operations may not be effective.
Gigabit Network	Enable Disable	Sets whether to support a Gigabit network.
Hub Link Setting	Auto Negotiate 100Base-TX Full 100Base-TX Half 10Base-T Full 10Base-T Half	Sets the connection mode to the hub.
Network Factory Defaults	Execute	Restores the settings, such as network, mail server, LDAP server, and secure protocol server, etc., to their default values.

*1: Appears when [Enable] is set on the control panel for [TCP/IP].

*2: Appears when [Manual] is set on the control panel for [IP Address Set].

■ USB Setup

• Shaded areas are factory-set values.

Item	Value	Description
USB	Enable Disable	Enables/disables access using a USB interface.
Speed	480Mbps 12Mbps	Sets the maximum baud rate using a USB interface.
Soft Reset	Enable Disable	Enables/disables the software reset command.
Serial Number	Enable Disable	Enables/disables the USB serial number. The USB serial number is used to identify USB devices connected to a PC.
Offline Receive	Enable Disable	Sets whether to receive data even if offline or a recoverable error occurs.

■ Print Setup

• Shaded areas are factory-set values.

Item		Value	Description
Personality		Auto PCL PostScript	Select the print language. Print language switching is automatic when set to [Auto].
Copies		1 9999	Sets the copy quantity. This setting is ignored in case of local print. This setting is disabled unless the [Job Copy] setting is 1.
Job Copy		1 999	Sets the print quantity. This setting is ignored in case of local print. The settings in the printer driver always overwrite these settings. * This setting is enabled only if [Collate] is checked and 1 is specified as the number of copies in the PCL printer driver.
Edge to Edge		On Off	Sets the print margin.
Resolution		600dpi 1200dpi	Sets the resolution.
Toner Save	Toner Save Level	Off Low Middle High	Set the toner save quantity. Specifies [Off] when toner save mode is disabled.
	Color	All Except 100% Black	All: All colors, including 100% black, comprise all the target colors for toner saving. Except 100% Black: All colors, excluding 100% black, comprise all the target colors for toner saving.
Check Unnecessary Print Cartridge		On Off	Set whether to generate an error or continue printing when a print cartridge is detected to be down even though it is not being used as a specified color for the print data. On: An error is displayed and the print job is cancelled, to give priority to the service life of the print cartridge. Off: A warning screen is displayed, but printing continues because priority is given to productivity.
Default Orientation		Portrait Landscape	Sets the print orientation.
Trapping		Off Narrow Narrow / Choke White Wide Wide / Choke White Choke White	Sets trapping.

■ PS Setup

• Shaded areas are factory-set values.

Item	Value	Description
Network Protocol	ASCII RAW	Specifies the PS communication protocol mode for data from the network.
USB Protocol	ASCII RAW	Specifies the PS communication protocol mode for data from USB.

■ PCL Setup

• Shaded areas are factory-set values.

Item	Value	Description
Font Source	Resident Downloaded	Sets the location of the fonts to be used.
Font Number ^{*1}	I0 S1	Sets the numbers of the fonts to be used.
Font Pitch	0.44 CPI ? 10.00 CPI 99.99 CPI	Sets the font width. Increases and reduces in 0.01 CPI units. Displayed when the font selected using [Font Number] is an outline font with fixed spacing.
Font Height	4.00 points 12.00 points 999.75 points	Sets the font height. Increases and reduces in 0.25 point units. Displayed when the font selected using [Font Number] is an outline font with variable spacing.
Symbol Set	PC-8 PC-8 Dan/Nor PC-8 Grk PC-8 TK PC-775 PC-850 PC-851 Grk PC-852 PC-855 PC-857 TK PC-858 PC-862 Heb PC-866 PC-866 Ukr PC-869 PC-1004 Pi Font Plska Mazvia PS Math PS Text Roman-8 Roman-9 Roman Ext Serbo Croat1 Serbo Croat2 Spanish UCS-2 Ukrainian VN Int'l VN Math VN US Win 3.0 Win 3.1 L/G Win 3.1 Blt	Select the symbol set.

*1: Refer to "Resident Fonts" (P.71) about the Font Number to be used.

⌘ Shaded areas are factory-set values.

Item	Value	Description
Symbol Set	Win 3.1 Cyr Win 3.1 Grk Win 3.1 Heb Win 3.1 L1 Win 3.1 L2 Win 3.1 L5 Wingdings Dingbats MS Symbol OCR-A OCR-B OCRB Subset2 HP ZIP USPSFIM USPSSTP USPSZIP Bulgarian CWI Hung DeskTop German Greek-437 Greek-437 Cy Greek-737 Greek-8 Greek-928 Hebrew NC Hebrew OC Hebrew-7 Hebrew-8 IBM-437 IBM-850 IBM-860 IBM-863 IBM-865 ISO Dutch ISO L1 ISO L2 ISO L4 ISO L5 ISO L6 ISO L9 ISO Swedish1 ISO Swedish2 ISO Swedish3 ISO-2 IRV ISO-4 UK ISO-6 ASC ISO-10 S/F ISO-11 Swe ISO-14 JASC ISO-15 Ita ISO-16 Por ISO-17 Spa ISO-21 Ger ISO-25 Fre ISO-57 Chi ISO-60 Nor ISO-61 Nor ISO-69 Fre ISO-84 Por ISO-85 Spa ISO-Cyr ISO-Grk ISO-Hebrew	Select the symbol set.

⌘ Shaded areas are factory-set values.

Item	Value	Description
Symbol Set	Kamenicky Legal Math-8 MC Text MS Publish PC Ext D/N PC Ext US PC Set1 PC Set2 D/N PC Set2 US	Select the symbol set.
CR Function	CR CR+LF	Specifies the operation when a CR code is received.
LF Function	LF LF+CR	Specifies the operation when an LF code is received.
Print Margin	Normal 1/5 inch 1/6 inch 1/8 inch 1/12.5 inch	Sets the area of the paper where printing is not possible.
True Black	On Off	Specifies whether to use mixed CMYK or black toner only for printing black of image data.
Pen Width Adjust	On Off	Compensates so that thin lines are visible.

■ Color Setup

• Shaded areas are factory-set values.

Item	Value	Description
Ink Simulation	Off SWOP ISO Coated Japan	Sets the ink simulation. This setting is enabled only for PS language jobs.
UCR	Low Normal High	You can select the black plate (black) amount during color printing. Setting more black plate economizes on the toner of the other three colors.
CMY 100% Density	Enable Disable	Enables/disables 100% output for CMY 100% shade values.
CMYK Conversion	On Off	You can select the method of total toner quantity control for CMYK data. Select [Off] to disable GCR (Gray Component Replacement). Furthermore, this menu setting is disabled if using the ink simulation function.

■ Panel Setup

• Shaded areas are factory-set values.

Item	Value	Description
Idle Display	Supplies Life Unwinder Config	Sets the information displayed in the standby screen.
Panel Brightness During Operation	5 1 31	Adjusts the brightness (backlight luminosity) of the control panel LCD. The set brightness is applied during control panel operations.
Panel Brightness While Power Save	0 1 1 31	Adjusts the brightness (backlight luminosity) of the control panel LCD. The set brightness is applied after the panel backlight timer time has elapsed from the last operation.
Panel Backlight Timer	10 1 30 1 300	Adjusts the time (in seconds) from the last operation until [Panel Brightness While Power Save] is applied.

■ Time Setup

• Shaded areas are factory-set values.

Item	Value	Description
Date Format	yyyy/mm/dd mm/dd/yyyy dd/mm/yyyy	Sets the date display mode. The initial values vary depending on your operating environment.
Time Zone	-12:00 1 +0:00 1 +13:00	Sets the time difference from GMT in 15-minute units. If the time zone setting is changed, the time differences before and after the change are reflected in the current time.
Daylight Saving	On Off	Sets whether to display daylight saving time. On: Sets the current time 1 hour forward. Off: Sets the current time 1 hour back.
Time Setting	2000/01/01 00 :00 1 2091/12/31 23 :59	Sets the time.

■ Power Setup

• Shaded areas are factory-set values.

Item	Value	Description
Power Save	Enable Disable	Enables/disables power save mode.
Auto Power Off	Enable Auto Config Disable	Sets auto power off mode.

■ Others Setup

• Shaded areas are factory-set values.

Item	Value	Description	
RAM Setup	Receive Buffer Size	Auto 0.5 MB 1 MB 2 MB 4 MB 8 MB 16 MB 32 MB	Sets the incoming buffer size that is assured by the local interface.
	Resource Save	Auto Off 0.5 MB 1 MB 2 MB 4 MB 8 MB 16 MB 32 MB	Sets the resource saving area size.
Storage Common Setup	Check File System	Execute	Implements management data (FAT information) recovery, and resolves mismatches between the actual (free) space in the file system and the free space displayed.
	Check All Sectors	Execute	Recovers defective sector information on the HDD and file system nonconformances.
	Enable Initialization	No Yes	Specifies whether or not to authorize setup changes associated with HDD and flash memory initialization.
Language Setup	Select Language	Chinese English French German Italian Japanese Russian Spanish	Specifies the control panel display language.
	Language Initialize	Execute	Deletes the message files that have been downloaded. Also, the [Select Language] setting returns to the factory default setting.
Job Cancel Setup	Cancel Key Behavior	Short Long Off	Sets the operations when the device <CANCEL> button is pressed. Short: Hold down no longer than two seconds to cancel the print job. Long: Hold down for 2 to 5 seconds to cancel a print job. Off: Disables the <CANCEL> button.
	Inquiry Display	On Off	Sets whether to display the enquiry screen when a job is canceled.
	Focus Position	Yes No	Sets whether to apply [Yes] or [No] focus for selection in the job cancellation enquiry screen.
	Display Timeout	60 180 300	Sets the display timeout value for the enquiry screen when a job is canceled.

- Shaded areas are factory-set values.

Item	Value	Description	
Media Operation Setup	Inquiry Display	On Off	Specifies the operation when the <FEED> button or the <UNLOAD> button is pressed. On: In the cases below, a confirmation screen is displayed before the operation is executed. <FEED>: When the paper changes from a stand-by state to a through paper state <UNLOAD/CUT>: When cut is executed Off: Operation is performed without displaying a confirmation message.
	Rewinder Distance	600 millimeter (24 inch) 900 millimeter (36 inch) 1200 millimeter (48 inch)	Specifies the amount to be fed when the <FEED> button is pressed in the stand-by state, using the output slot as the reference point.
	Feed Distance	150 millimeter (6 inch) 300 millimeter (12 inch) 450 millimeter (18 inch)	Specifies the amount to be fed when the <FEED> button is pressed in the through paper state, using the current position as the reference point.

■ Settings

- Shaded areas are factory-set values.

Item	Value	Description
Reset Settings	Execute	Restores the user menu settings to the factory settings.
Save Settings	Execute	Saves the current menu settings.
Restore Settings ^{*1}	Execute	Changes the saved menu settings.

*1: Displayed when [Save Settings] is executed on the control panel.

■ Change Password

- Shaded areas are factory-set values.

Item	Value	Description
New Password	*****	Sets a new password to be entered in the [Admin menu] and [Boot Menu].
Verify Password	*****	Sets a new password to be entered in the [Admin menu] and [Boot Menu] for which [New Password] has been set.

■ Resident Fonts

Item	Font Name List
I0	Courier
I1	Courier Bold
I2	Courier Italic
I3	Courier Bold Italic
I4	CG Times
I5	CG Times Bold
I6	CG Times Italic
I7	CG Times Bold Italic
I8	CG Omega

Table of Setting Items in the Control Panel Menu Screen

Item	Font Name List
I9	CG Omega Bold
I10	CG Omega Italic
I11	CG Omega Bold Italic
I12	Coronet
I13	Clarendon Condensed
I14	Univers Medium
I15	Univers Bold
I16	Univers Medium Italic
I17	Univers Bold Italic
I18	Univers Medium Condensed
I19	Univers Bold Condensed
I20	Univers Medium Condensed Italic
I21	Univers Bold Condensed Italic
I22	Antique Olive
I23	Antique Olive Bold
I24	Antique Olive Italic
I25	Garamond Antique
I26	Garamond Halbfett
I27	Garamond Kursiv
I28	Garamond Kursiv Halbfett
I29	Marigold
I30	Albertus Medium
I31	Albertus Extra Bold
I32	Letter Gothic
I33	Letter Gothic Bold
I34	Letter Gothic Italic
I35	Arial
I36	Arial Bold
I37	Arial Italic
I38	Arial Bold Italic
I39	Times New
I40	Times New Bold
I41	Times New Italic
I42	Times New Bold Italic
I43	ITC Avant Garde Gothic Book
I44	ITC Avant Garde Gothic Demi
I45	ITC Avant Garde Gothic Book Oblique
I46	ITC Avant Garde Gothic Demi Oblique
I47	ITC Bookman Light
I48	ITC Bookman Demi
I49	ITC Bookman Light Italic
I50	ITC Bookman Demi Italic
I51	Courier PS
I52	Courier PS Bold
I53	Courier PS Oblique
I54	Courier PS Bold Oblique
I55	Helvetica

Table of Setting Items in the Control Panel Menu Screen

Item	Font Name List
I56	Helvetica Bold
I57	Helvetica Oblique
I58	Helvetica Bold Oblique
I59	Helvetica Narrow
I60	Helvetica Narrow Bold
I61	Helvetica Narrow Oblique
I62	Helvetica Narrow Bold Oblique
I63	New Century Schoolbook Roman
I64	New Century Schoolbook Bold
I65	New Century Schoolbook Italic
I66	New Century Schoolbook Bold Italic
I67	Palatino Roman
I68	Palatino Bold
I69	Palatino Italic
I70	Palatino Bold Italic
I71	Times Roman
I72	Times Bold
I73	Times Italic
I74	Times Bold Italic
I75	ITC Zapf Chancery Medium Italic
I76	Symbol
I77	Symbol PS
I78	Wingdings
I79	ITC Zapf Dingbats
I80	OCRB Subset2
I81	Line Printer
I82	OCR-A
I83	OCR-B
I84	USPS POSTNET Bar Codes

◇ Scalable: 81 fonts (No.I0-80)

◇ Bitmap: 4 fonts (No.I81-84)

◇ Total 85 fonts

[Print Statistics]



Note

- To enter this menu, it is necessary to enter the [Password].
- In the default factory settings, the password is [0000].

• Shaded areas are factory-set values.

Item		Value	Description
Usage Report		Enable Disable	Enables/disables the Usage Report function.
Supplies Report ^{*1}		Enable Disable	Sets whether or not to display the number of consumables replacements.
Reset Main Counter ^{*1}		Execute	Resets the main counter aggregate value.
Reset Supplies Counter ^{*2}		Execute	Resets the number of consumables replacements.
Change Password ^{*1}	New Password	****	Sets the new password to be entered in [Print Statistics].
	Verify Password	****	Sets a new password to be entered in the [Print Statistics] for which [New Password] has been set.

*1: Not displayed if [Disable] is set for the control panel [Print Statistics] > [Usage Report] item.

*2: Not displayed if [Disable] is set for the control panel [Supplies Report] item.

[Calibration]

- Shaded areas are factory-set values.

Item		Value	Description		
Auto Density Mode		On Off	Sets whether to automatically compensate density and shade.		
Adjust Density		Execute	Implements density compensation. Implement when the device is in stand-by status.		
Adjust Registration		Execute	Implements auto color misalignment compensation operations. Implement when the device is in stand-by status.		
Color Density	Cyan Density	-3 ? 0 ? +3	Adjusts the cyan density. This setting is enabled from printing after the density compensation has been implemented.		
		Magenta Density	-3 ? 0 ? +3	Adjusts magenta density. This setting is enabled from printing after the density compensation has been implemented.	
			Yellow Density	-3 ? 0 ? +3	Adjusts yellow density. This setting is enabled from printing after the density compensation has been implemented.
				Black Density	-3 ? 0 ? +3
		White Density	-3 ? 0 ? +3		Adjusts white density. This setting is enabled from printing after the density compensation has been implemented.
Print Color Tuning Pattern		Execute	Prints patterns to match the shading characteristics.		
Base Color Tuning	Highlight	A-1 A-2 B-1 B-2 ? O-1 O-2	Matches the color balance for the parts displayed as most clear in the highlight area of the printed color tuning pattern. The matching results are reflected in the highlight matching values for cyan, magenta, and yellow matching.		
		Mid-Tone	A-1 A-2 B-1 B-2 ? O-1 O-2	Matches the color balance for the parts displayed as most clear in the mid-tone area of the printed color tuning pattern. The matching results are reflected in the mid-tone matching values for cyan, magenta, and yellow matching.	
			Dark	A-1 A-2 B-1 B-2 ? O-1 O-2	Matches the color balance for the parts displayed as most clear in the dark area of the printed color tuning pattern. The matching results are reflected in the dark matching values for cyan, magenta, and yellow matching.

⌘ Shaded areas are factory-set values.

Item		Value	Description	
Fine Color Tuning	Cyan Tuning	Highlight	-4 ⌘ 0 ⌘ +4	Matches the highlights (light areas) of the cyan shade characteristics.
		Mid-Tone	-4 ⌘ 0 ⌘ +4	Matches the intermediate areas of the cyan shading characteristics.
		Dark	-4 ⌘ 0 ⌘ +4	Matches the dark (dark areas) of the cyan shade characteristics.
	Magenta Tuning	Highlight	-4 ⌘ 0 ⌘ +4	Matches the highlights (light areas) of the magenta shading characteristics.
		Mid-Tone	-4 ⌘ 0 ⌘ +4	Matches the intermediate areas of the magenta shading characteristics.
		Dark	-4 ⌘ 0 ⌘ +4	Matches the dark (dark areas) of the magenta shading characteristics.
	Yellow Tuning	Highlight	-4 ⌘ 0 ⌘ +4	Matches the highlights (light areas) of the yellow shading characteristics.
		Mid-Tone	-4 ⌘ 0 ⌘ +4	Matches the intermediate areas of the yellow shading characteristics.
		Dark	-4 ⌘ 0 ⌘ +4	Matches the dark (dark areas) of the yellow shading characteristics.
Black Tuning	Highlight	-3 ⌘ 0 ⌘ +3	Matches the highlights (light areas) of the black shading characteristics.	
	Mid-Tone	-3 ⌘ 0 ⌘ +3	Matches the intermediate areas of the black shading characteristics.	
	Dark	-3 ⌘ 0 ⌘ +3	Matches the dark (dark areas) of the black shading characteristics.	

⌘ Shaded areas are factory-set values.

Item		Value	Description
Reset Color Tuning		Execute	Resets CMYK color matching.
White Tuning	Highlight	-3	Matches the highlights (light areas) of the white shading characteristics.
		0	
		+3	
Mid-Tone		-3	Matches the intermediate areas of the white shading characteristics.
		0	
		+3	
Dark		-3	Matches the dark (dark areas) of the white shading characteristics.
		0	
		+3	
Density Adjustment Media		Standard Media	Specifies the operation speed during a density adjustment operation. Standard Media: Density adjustment operation performed at normal speed. Narrow/Thick Media: Density adjustment operation performed at low speed.
		Narrow/Thick Media	
		Media	

[Boot Menu]



Note

- This menu is displayed in English only.

■ Boot Menu



Note

- To enter this menu, press and hold the <OK> button while turning ON the power supply.
- Confirm that [Boot Menu] is selected and then press the <OK> button.
- To enter this menu, it is necessary to enter the [Password].
- The factory default setting of the administrator password is [999999].

- Shaded areas are factory-set values.

Item		Value	Description
Storage Common Setup	Check File System	Execute	Executes management data (FAT information) recovery, and resolves mismatches between the actual (free) space in the file system and the displayed free space.
	Check All Sectors	Execute	Recovers defective sector information on the HDD and file system nonconformances.
Menu Lockout		On Off	Specifies whether or not to display menus on the control panel.
Panel Lockout		Mode1 Mode2 Off	Sets whether to disable the operations buttons on the control panel.

■ Troubleshooting



Note

- To enter this menu, press and hold the <OK> button while turning ON the power supply.
- Select [Troubleshooting] and then press the <OK> button.

Item	Value	Description
Sensor Calibration Reset	Execute	This resets all sensor calibration results to initial values.

□ Saving Toner When Printing

Saving Toner When Printing (Toner Save Mode)

You can print by economizing the toner consumption amount by reducing the page print density. Separately enable or disable the toner economy mode for 100% black.

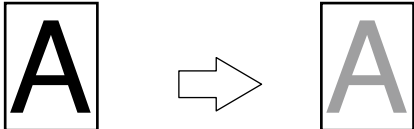

Memo

- You can suppress the quantity of toner used by selecting one of the following five patterns as necessary to reduce toner density.
 - Printer setting: Follows the printer's setup.
 - Off: Prints using regular density without economizing the toner.
 - Save Level Low: Prints using medium light toner.
 - Save Level Middle: Prints using light toner.
 - Save Level High: Prints using considerably light toner.
- [Toner Saving] is enabled only if the print quality is specified as [Normal] or [Draft].
- The settings on the printer can be changed from [Admin Setup] > [Print Setup] > [Toner Save]. However, the printer driver settings are given priority.



Note

- Toner save mode is not compatible with Spot Color printing.

Windows PCL printer driver

Open the file to be printed.

1

2

Select [Print] in the [File] menu.

3

Click [Preferences] (or [Properties]).

4

On the [Color] tab, use [Toner Saving] to select a toner save quantity.

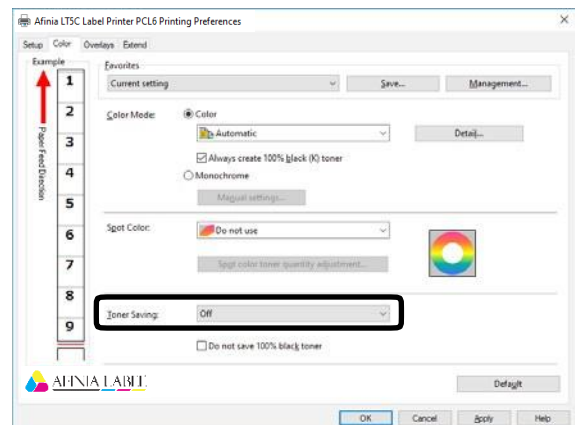

5

Print.

Printing Using the Specified Print Cartridge Only (Lift Up)

The lifespan of an unused print cartridge can be prolonged by separating it from the belt unit.

Setting combinations are shown in the table below.

Print Color	Print Cartridge to be Lifted Up
Black (K) only	Cyan, magenta, yellow, white*
White* (W) only	Black, cyan, magenta, yellow
Black + white*	Cyan, magenta, yellow
Black, cyan, magenta, yellow	White*

Example: Printing using the CMYK Print Cartridge only

In this example, the White (W) Print Cartridge is lifted up.

- 1** Grasping the Top Cover Open Lever, open the Top Cover.

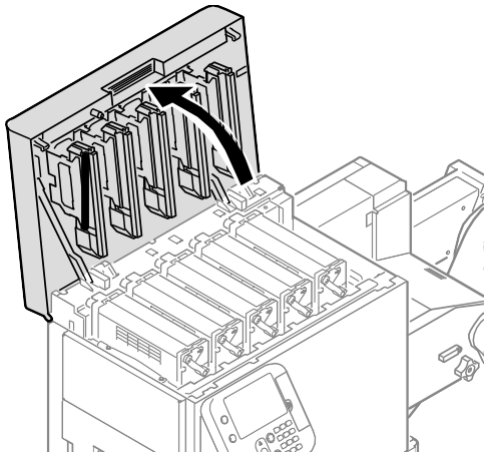

- 2** Check the position of the unused print cartridge via the label letters and color.

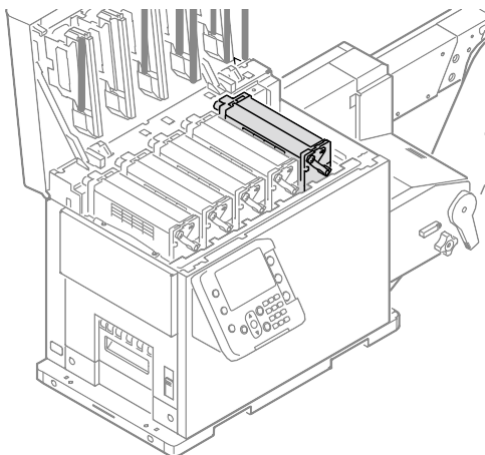

- 3** Turn the lift up lever on the print cartridge that is not being used clockwise to raise the print cartridge.

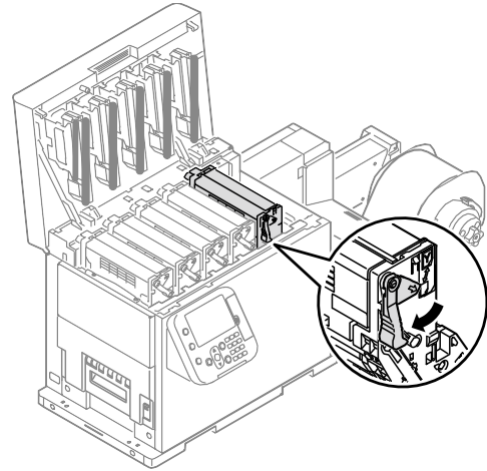

- 4** Close the top cover.

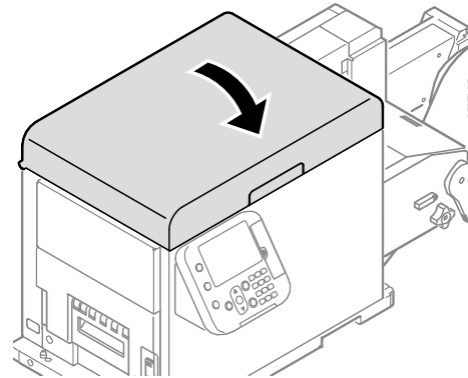

Note

- When closing the Top Cover, there is a risk of pinching your fingers at the Top Cover support point and Top Cover. Press the top of the Top Cover to close it.
- When closing the Top Cover while grasping the LED head, there is a risk of pinching your fingers or hands. Press the top of the Top Cover to close it.

□ Fine Quality Printing

Changing Print Quality (Resolution)

Set [Quality] by aligning to the environment in which it is used.



- Selecting [Fine/Detail(1200x1200 dpi)] prints at the highest quality available with the printer.

■ Windows PCL Printer Driver

- 1 Open the file to be printed.
- 2 Select [Print] in the [File] menu.
- 3 Click [Preferences] (or [Properties]).
- 4 On the [Setup] tab, change the [Quality] setting.

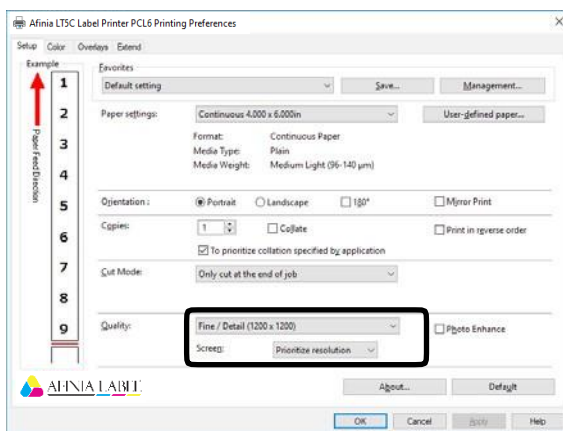

- 5 Print.

Making Photograph Printing More Vivid (Photo Enhance)

You can print more natural and vivid images, such as photos, etc.



- This function can be used with Windows PCL printer drivers only.

■ Windows PCL Printer Driver

- 1 Open the file to be printed.
- 2 Select [Print] in the [File] menu.
- 3 Click [Preferences] (or [Properties]).
- 4 On the [Setup] tab, select [Photo Enhance] in the [Quality] section, and then click [OK].

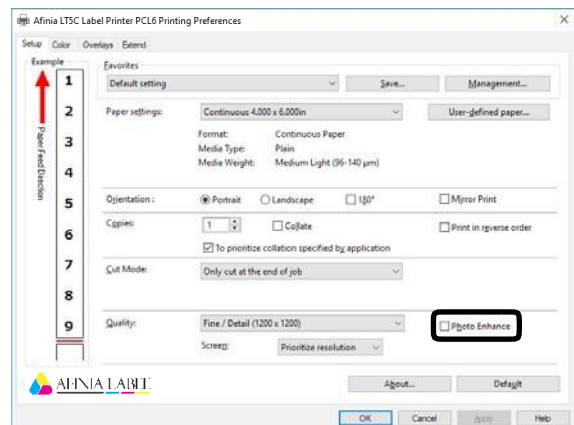

- 5 Print.

Adjusting Fine Lines

You can prevent misaligned lines being printed when ultra-fine lines are specified from the application.

This function is normally ON.



- Depending on the application, bar code and other intervals will narrow. In this case, turn OFF the function.

■ Windows PCL Printer Driver

- 1 Open the file to be printed.
- 2 Select [Print] in the [File] menu.
- 3 Click [Preferences] (or [Properties]).
- 4 On the [Extend] tab, click [Advanced].

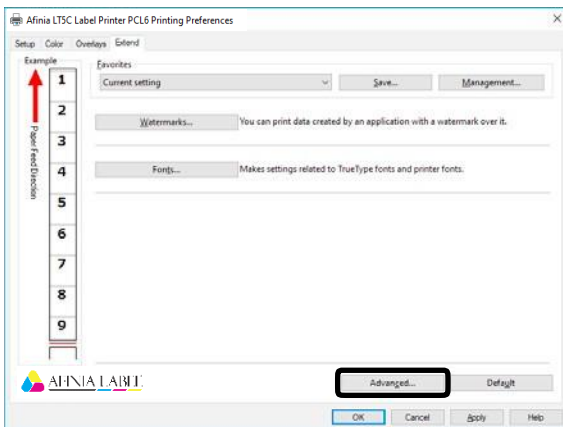

- 5 Select [Adjust ultra fine lines]. Next, select [Off] for [Settings], and then click [OK].

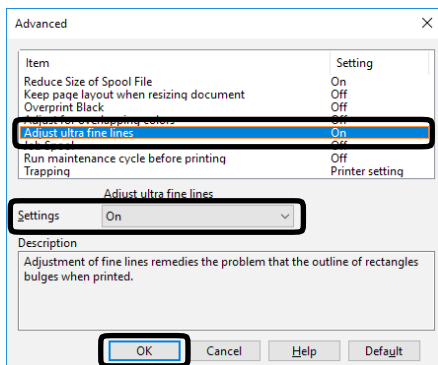

- 6 Print.

Using Printer Fonts

You can print by replacing TrueType fonts with printer built-in fonts.



- The font replacement function stores the document fonts, but font designs cannot be reproduced. If it is necessary to print font designs accurately, disable the font replacement function.
- In some applications, the font replacement function may not work properly.

■ Windows PCL Printer Driver

- 1 Open the file to be printed.
- 2 Select [Print] in the [File] menu.
- 3 Click [Preferences] (or [Properties]).
- 4 Click the [Extend] tab, and then select [Fonts].

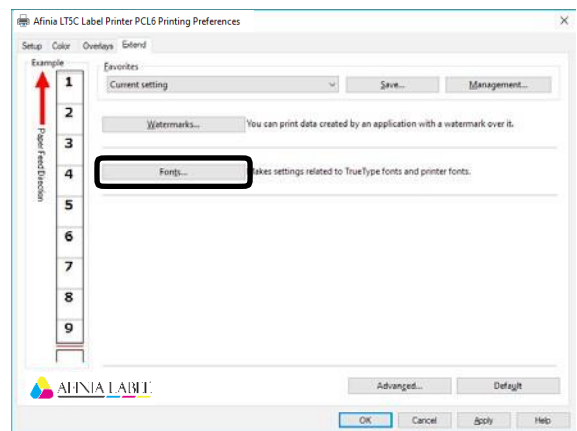

Using Computer Fonts

5 On the "Font" screen, select the [Font Substitution] check box.

For this printer, this check box is selected as the default setting.

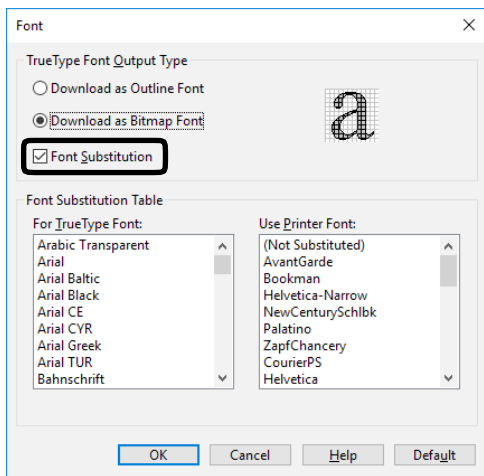

6 Use the [Font Substitution Table] to specify which printer fonts should replace the TrueType fonts.

7 Print.

You can output TrueType fonts as they appear on the screen.



Note

- Print time may be longer.

■ Windows PCL Printer Driver

- 1** Open the file to be printed.
- 2** Select [Print] in the [File] menu.
- 3** Click [Preferences] (or [Properties]).
- 4** On the [Extend] tab, click [Fonts].
- 5** On the "Font" screen, clear the [Font Substitution] check box.
 - Download as Outline Font
Font image is created by the printer.
 - Download as Bitmap Font
Font information is created by the printer driver.

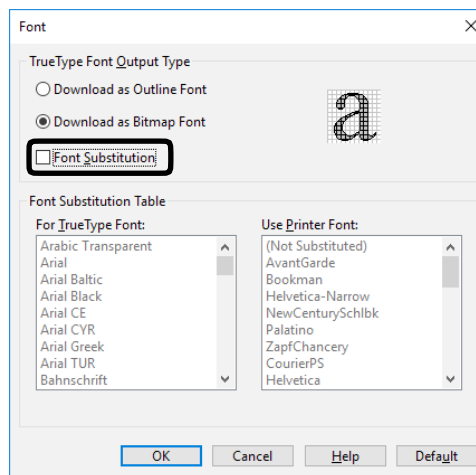

6 Print.

□ Adjusting the Print Position on the Paper

You can correct the print start position vertically and horizontally on the paper by the printer settings. Please refer to the following procedure.

Using the roll paper

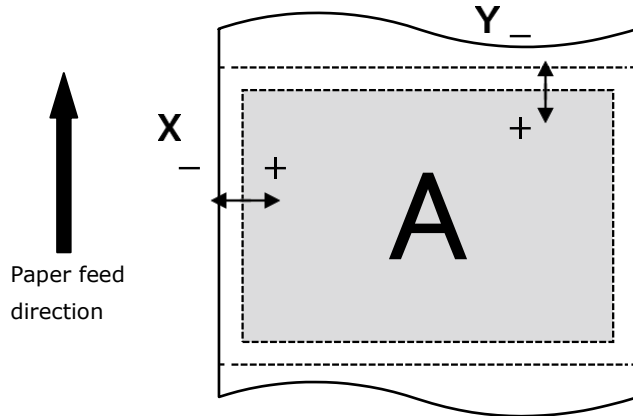

- 1 Press the <Fn> key. The numerical values input screen will be displayed.

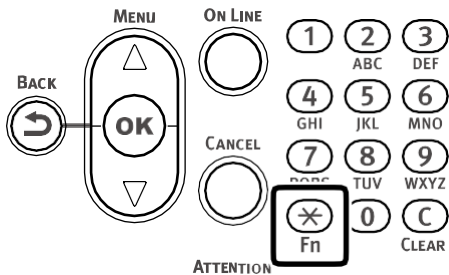

- 2 Press <2>, <2>, <0> (function numbers), and then press the <OK> button.

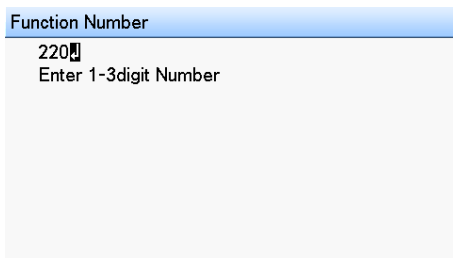

- 3 Press the scroll button▲ or ▼ to select the item you want to adjust.

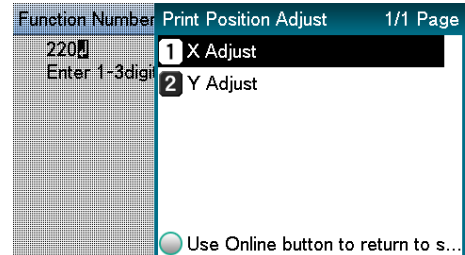

- 4 Press the <OK> button.

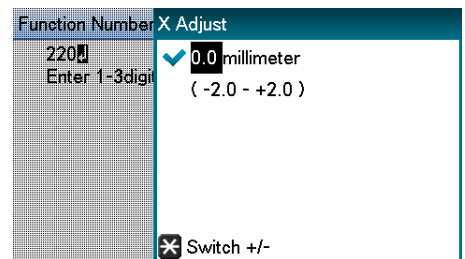

- 5 Press the scroll button▲ or ▼ to select the amount of the adjustment, and then press the <OK> button. Confirm there is a check mark (✓) to the left of the selected value.

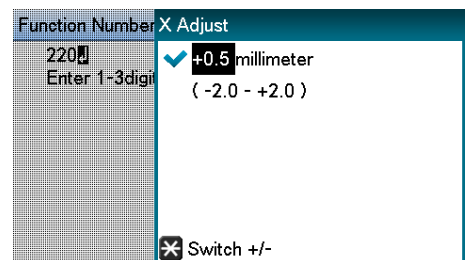

! Note

- Y represents the paper feed direction and X represents the orthogonal position relative to the paper feed direction.
- Set positive [+] numbers to widen the blank space in the X direction, and also set positive [+] numbers to widen the blank space in the Y direction.
- Readjustment might be necessary depending on the usage conditions (temperature, humidity, media type).
- By eliminating the differences between printers and using the same settings on all the printers with this procedure, you can use one computer when you want to get the same print results on multiple printers. Refer to "Using the Printer Driver to Fine-tune the Print Position" (P.16) about setting the computer.

Adjust the position using [Y Adjust] in [Menus]>[Print Adjust]>[Print Position Adjust].

Adjusting the Position That Printing Starts

This section explains how to better align the position at which printing starts for die-cut label paper (with black mark), continuous label (with black mark), and die-cut label paper.

This adjustment is unnecessary if your print jobs do not require accurate positioning of where printing starts.

- 1 Adjust the position that printing starts on the first page.

After setting the size of the media, calibrate the sensor and execute Paper interval detection.

- 2 In the driver's print settings, set [To specify the number of pages per cut] in [Cut Mode] and set [1] in [Page(s) per cut].



Note

- You may not be able to set [1] in [Page(s) per cut] if the paper on which you are printing is shorter than 101.6 mm. If this is the case, set the smallest value that you can select.

- 3 Print five pieces of the media on which you are actually printing.
- 4 Measure the distance at A or B, as shown in the diagram, for all five sheets and then calculate the average of these values.
- 5 Calculate the difference in the position you want to print and the average value from (4).

When using a black mark sensor

At the point that the black mark intersects the position of the black mark sensor on the printer, measure the distance at A from the leading edge of the black mark to the printed matter on five sheets.

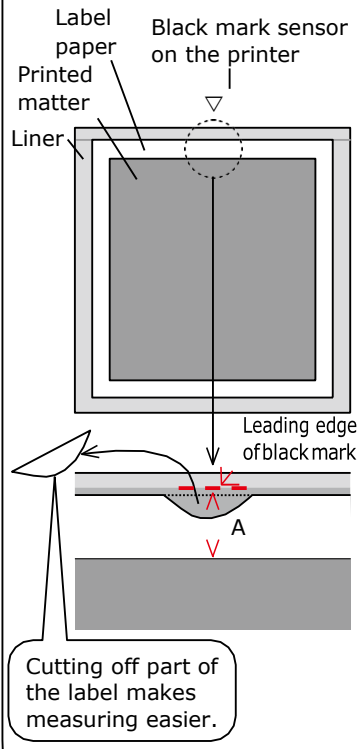

When using a gap sensor

At the point that the label intersects the position of the gap sensor on the printer, measure the distance at B from the leading edge of the label to the printed matter on five sheets.

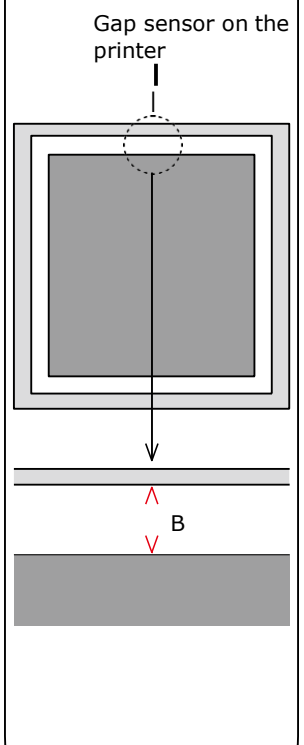

Memo

- About Print Position Adjust (Y Adjust)
Plus and minus direction for Y adjust

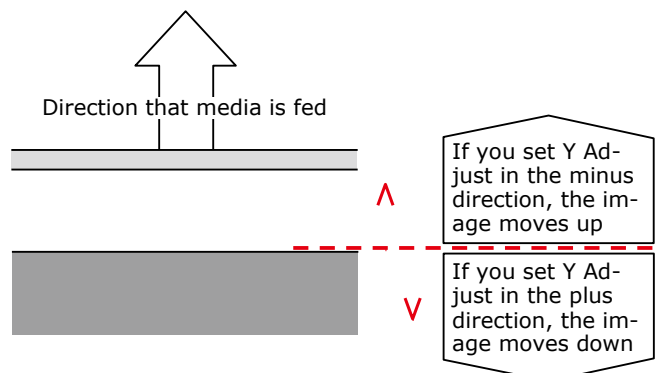

2 If you are actually printing more than two sheets consecutively, then next, do the following adjustment.
(Improve the accuracy of the function for learning the position that printing starts)

(1) In the driver's print settings, set [To specify the number of pages per cut] in [Cut Mode] and set [20] in [Page(s) per cut].

(2) Print 20 pieces as a test print (*).
* These printouts are test prints for adjusting positions, so throw them away when you are done.

3 The adjustments are complete when printing is done in the position you want.

Reset the cutter settings, and then start printing.

Other Print Functions

Specifying the Page Order

Extracts by page order when printing documents with multiple pages.

There are two methods.

- Printing documents in page order.
- Printing documents in reverse page order.

Windows PCL Printer Driver

- 1 Open the file to be printed.
- 2 Select [Print] in the [File] menu.
- 3 Click [Preferences] (or [Properties]).
- 4 On the [Setup] tab, select the [Print in reverse order] check box in the [Copies] area.

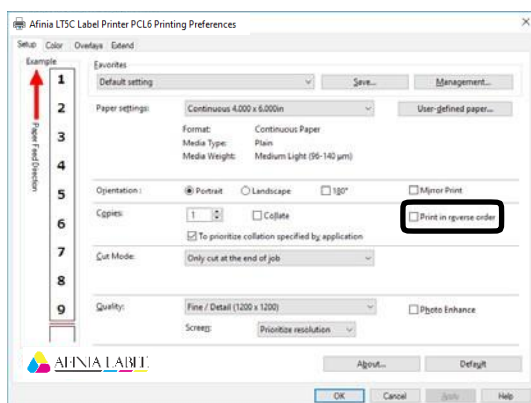

- 5 Print.

Overlaying Stamps for Printing (Watermarks)

The details to be printed from the application can be independently printed overlaying [Samples], [Confidential], etc.

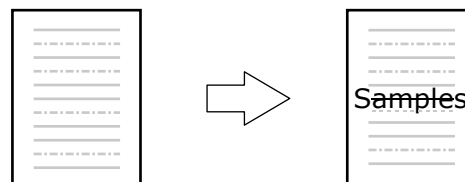

Windows PCL Printer Driver

- 1 Open the file to be printed.
- 2 Select [Print] in the [File] menu.
- 3 Click [Preferences] (or [Properties]).
- 4 On the [Extend] tab, click [Watermarks].

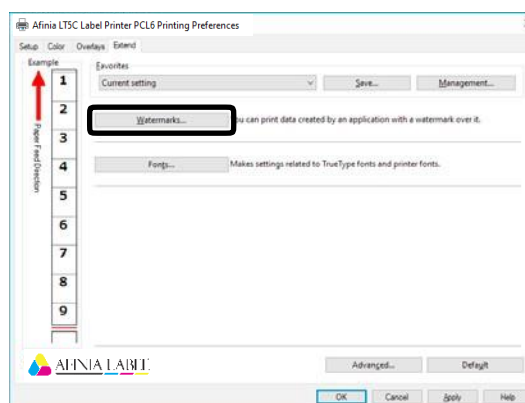

5 Click [New].

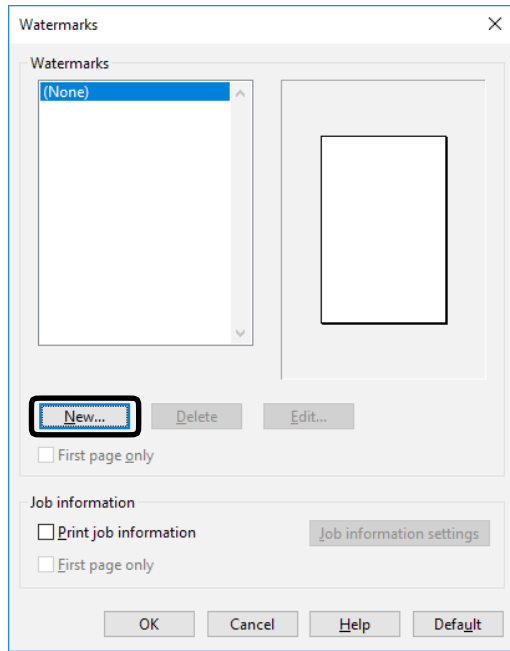

6 On the "Watermarks" screen, enter text into [Text], and configure [Size] and other settings.

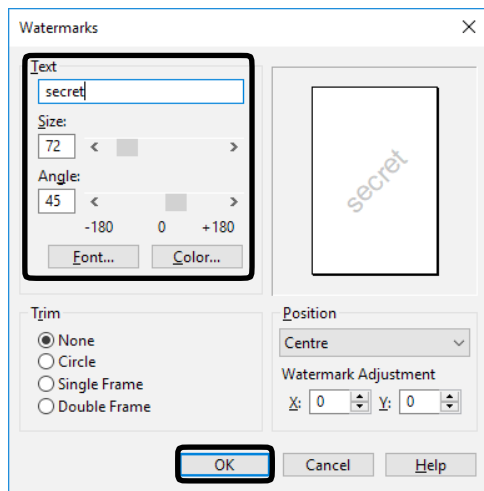

7 Click the <OK> button.

8 Print.

Collating Printed Output (Sorted Printing)

You can store print jobs in the device memory and collate the printing.

Printing by specifying batches

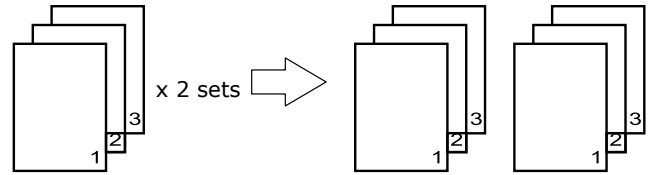

Printing without specifying batches

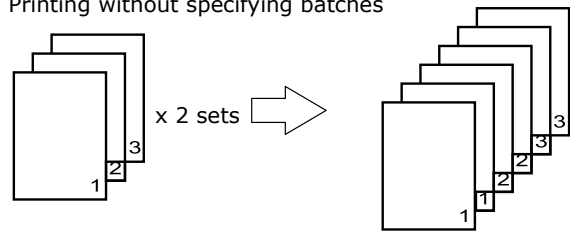

- Not usable with some applications.

■ Windows PCL Printer Driver

- 1 Open the file to be printed.
- 2 Select [Print] in the [File] menu.
- 3 Click [Preferences] (or [Properties]).
- 4 On the [Setup] tab, enter a value for [Copies], and then select the [Collate] check box.

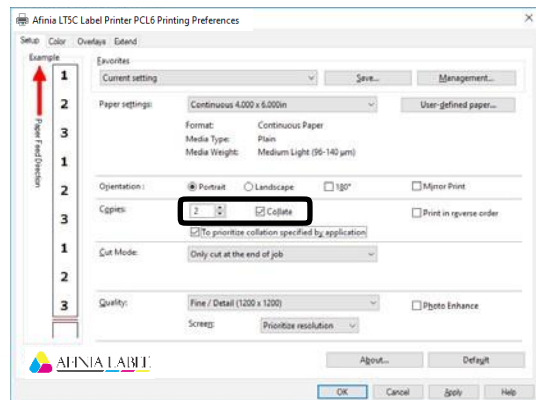

5 Print.

Printing a Mirror Image

Print using mirror print when you want to print image to appear normal when the page is viewed from the back.

■ Windows PCL Printer Driver

1 Click [Start] and select [Control Panel] in [Windows System].

2 Click [View devices and printers].

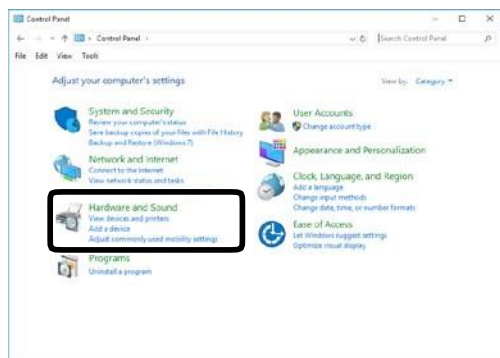

3 Right-click the [LT5C PCL6] icon, and then select [Printer Properties].

4 Select [General] tab, and then click [Preferences].

5 On the [Setup] tab, select the [Mirror Print] check box in the [Orientation] section, and then click [OK].

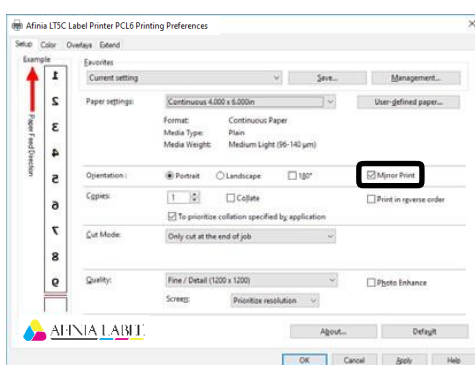

6 Open the file to be printed.

7 Select [Page Setup] in the [File] menu.

8 Select the paper size and print orientation, and then click [OK].

9 Select [Print] in the [File] menu.

10 Click [OK] to return to the "Print" screen.

11 Click [Print] in the "Print" screen to print.

Printing Registered Forms (Print Overlay)

You can register forms, logos, etc., as forms to the device, and overlay for printing.

Memo

- To print an overlay, you need to create a form and register it in advance. It is possible to specify a maximum of four forms in one group. Forms are overlaid and printed in the order they are registered. That is to say, the last form you register is printed on top.

Windows PCL Printer Driver

1 Click [Start] and select [Control Panel] in [Windows System].

2 Click [View devices and printers].

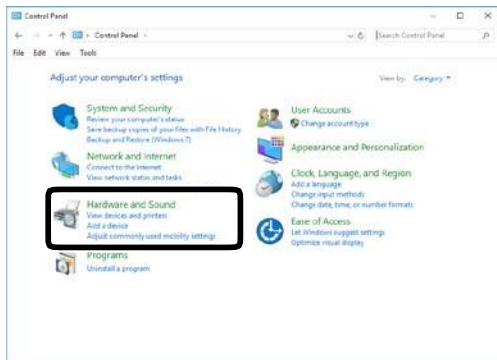

3 Right-click the [LT5C PCL6] icon, and then select [Printing preferences].

4 Click the [Overlays] tab.

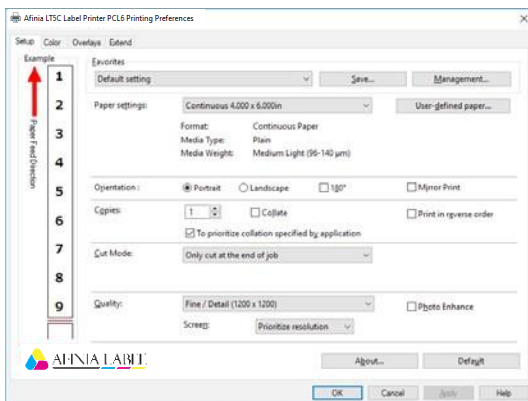

5 On the [Overlays] tab, select [Register print document as a new form].

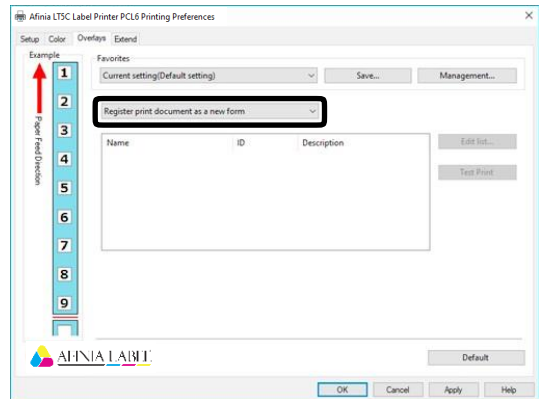

Memo

- If the form you want to print is already registered to the device, you do not need to do steps 5 through 10. Advance to step 11 of this procedure.

6 Click [Apply] > [OK] to close the "Printing Preferences" screen.

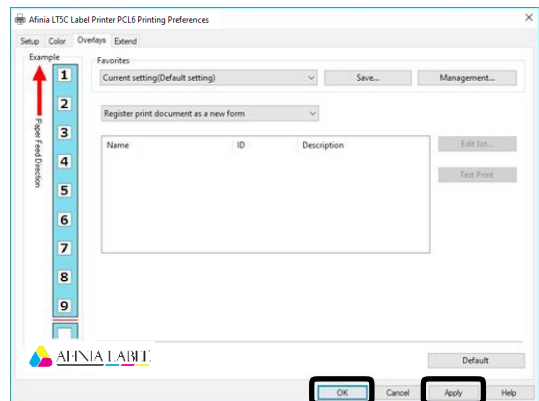

7 From the application, print the image you want to register as a form.

8 Confirm that the [New Form] screen appears.

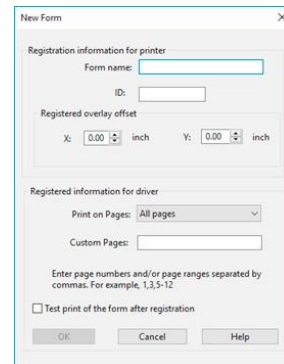

9 Input the [Form name] and [ID], and then click [OK].

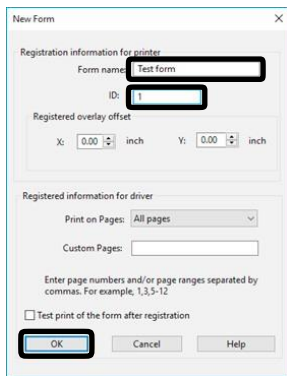

13 Perform the following operation to close the "Printing Preferences" screen: [Apply] > [OK].

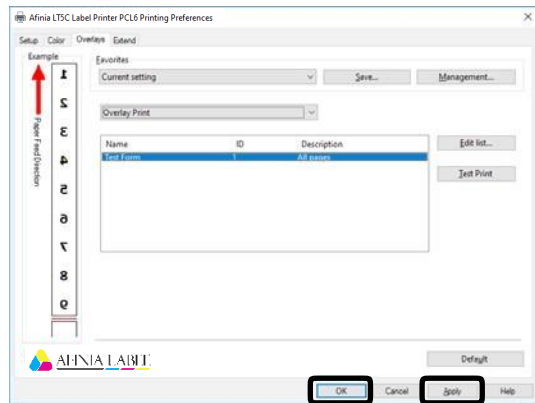

10 The form is sent to the device and registered with the specified ID.

11 On the [Overlays] tab, select [Overlay Print].

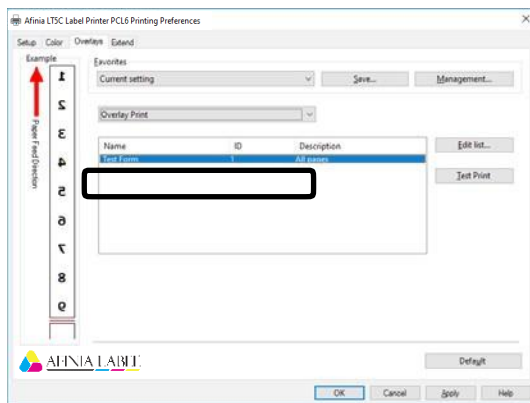

14 Print from the application.

12 Select the forms you want to use for overlay printing.

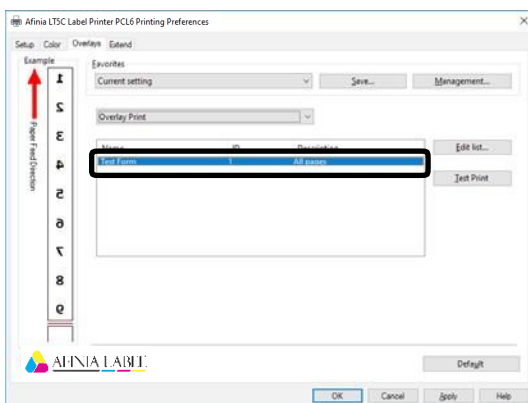

Outputting to a File Without Printing

You can write and save to a file without printing the print data.



Note

- PC administrator privileges are required.

■ Windows PCL Printer Driver

- 1 Click [Start] and select [Control Panel] in [Windows System].
- 2 Click [View devices and printers].

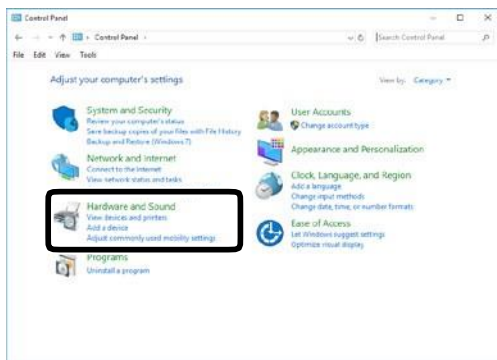

- 3 Right-click the [LT5C PCL6] icon, and then select [Printer Properties].
- 4 Select the [Ports] tab.
- 5 In the ports list, select [FILE:], and then click [OK].

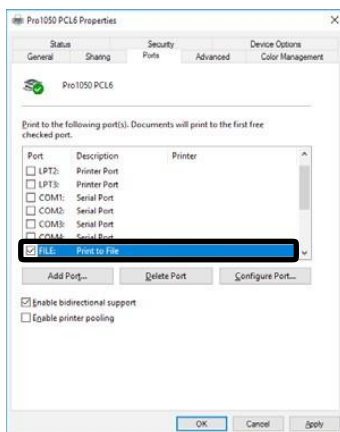

- 6 Print.
- 7 Enter the file name, and then click [OK].

Changing the Check Unnecessary Print Cartridge Setting

You can have an error displayed and cancel the print job to prioritize the service life of a print cartridge that is detected to be down even though it is not being used as a specified color for the print data.

- 1 Press the scroll button ▲ or ▼.

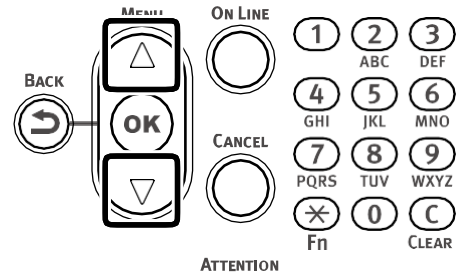

- 2 Select [Admin Setup], and then press the <OK> button.

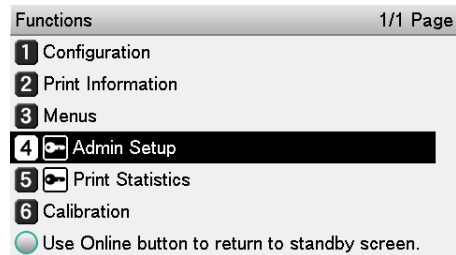

- 3 Enter the administrator password, and then press the <OK> button.



Memo

- The factory default setting of the administrator password is [999999].

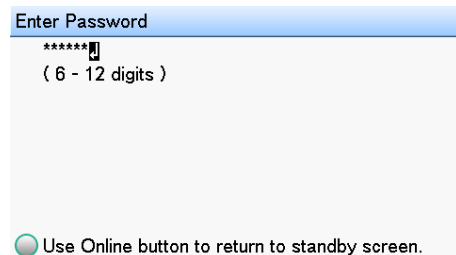

● Use Online button to return to standby screen.

4 Select [Print Setup], and then press the <OK> button.

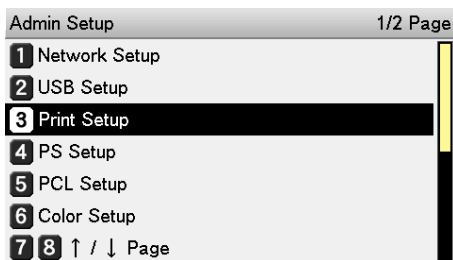

5 Select [Check Unnecessary Print Cartridge], and then press the <OK> button.

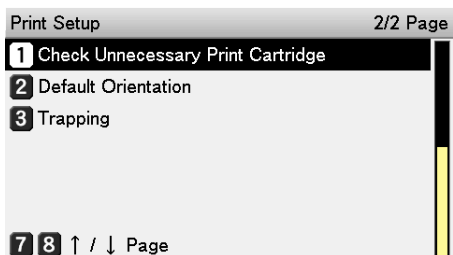

6 If you want an error to be generated when a print cartridge is detected to be down even though it is not being used as a specified color for the print data, select [On]. Select [Off] if you want printing to continue. Then, press the <OK> button.

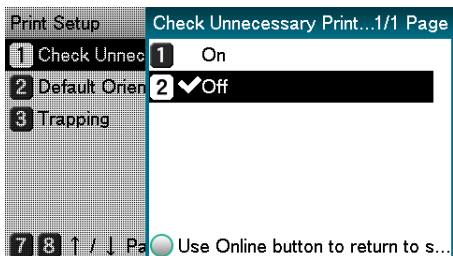

7 Press the <ON LINE> button to return to the standby screen.

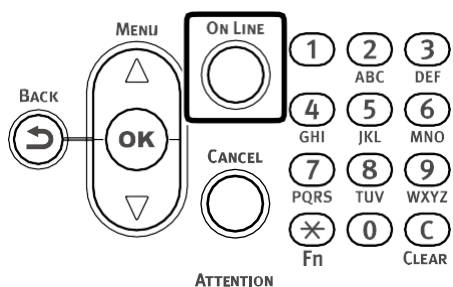

Saving Printer Driver Setups

You can save the details set using the printer drivers.

If you save the changes to the settings for multiple locations, then the next and following times you change the settings, all you have to do is specify the driver settings so that those settings in the multiple locations are automatically changed to the settings that you saved.

Save a Setup

1 Click [Start] and select [Control Panel] in [Windows System].

2 Click [View devices and printers].

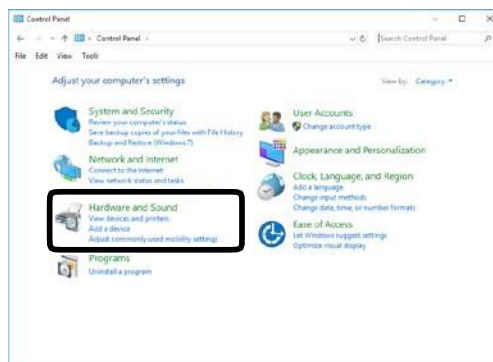

3 Right-click the [LT5C PCL6] icon, and then select [Printing preferences].

4 Change the settings to create the setup you want to save.

5 On the [Setup] tab, click [Save].

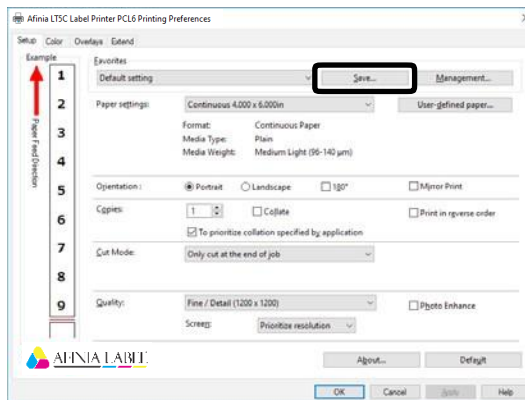

- Enter the setting name into [Save Favorites as], and then click [OK].

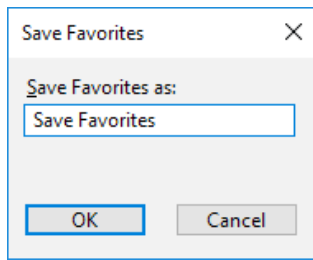

- Click [OK] to close the Print Setup dialog box.

Recall a Saved Setup

- Open the file to be printed.
- On the [File] menu, select [Print].
- Click [Preferences] (or [Properties]).
- On the [Setup] tab, configure [Favorites].

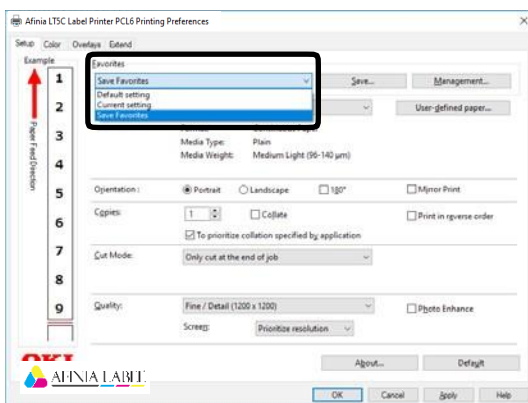

- Print.

Delete a Saved Setup

- Click [Start] and select [Control Panel] in [Windows System].
- Click [View devices and printers].

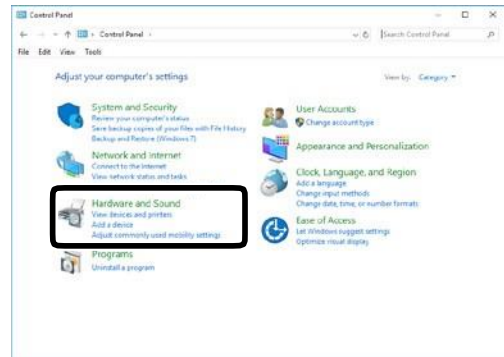

- Right-click the [LT5C PCL6] icon, and then select [Printing preferences].
- On the [Setup] tab, click [Management].
- Click [Delete].

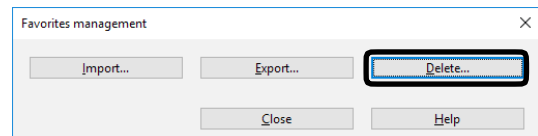

- Select the setup you want to delete, and then click [Delete].
- Click [Yes].

Importing/Exporting a Printer Driver Print Setup

You can convert printer driver print setup information to a file, and then export/import the file. The file extension for exporting/importing is ".xmn".

Export a Setup

1 Click [Start] and select [Control Panel] in [Windows System].

2 Click [View devices and printers].

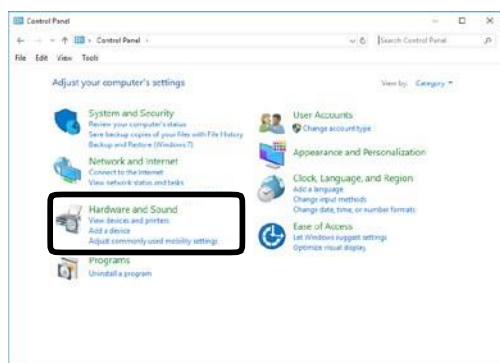

3 Right-click the [LT5C PCL6] icon, and then select [Printing preferences].

4 On the [Setup] tab, click [Management].

5 Click [Export].

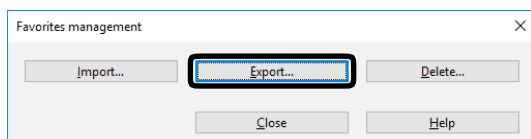

6 In the [List of favorite settings] on the "Export" screen, select the checkbox next to the setup you want to export, and then click [Export].

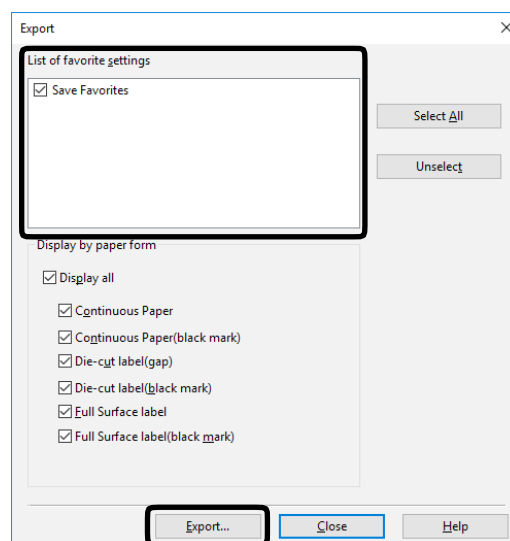

7 Enter a file name, specify where to save it, and then click [Save].

Import a Setup

1 Click [Start] and select [Control Panel] in [Windows System].

2 Click [View devices and printers].

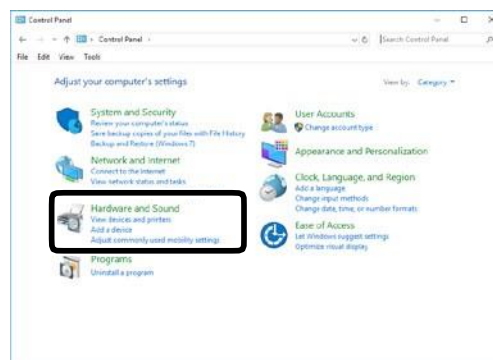

3 Right-click the [LT5C PCL6] icon, and then select [Printing preferences].

4 On the [Setup] tab, click [Management].

5 Click [Import].

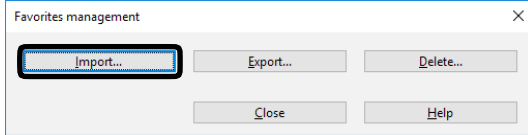

6 On the "Import" screen, click [Open the file].

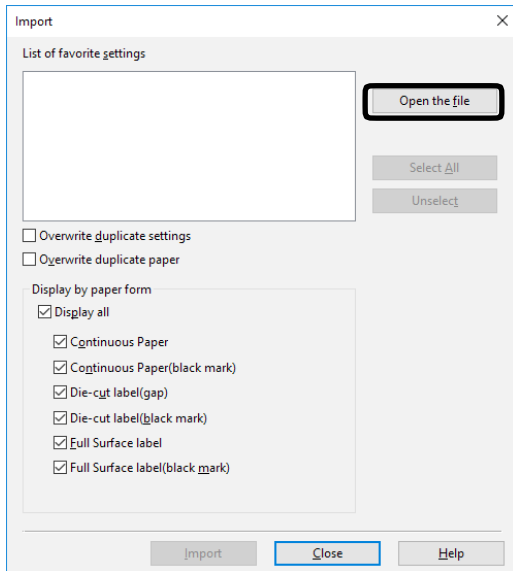

7 Specify the file you want to import, and then click [Open].

8 Check the names of the settings in the [List of favorite settings], and then click [Import].

9 When the message "Imported successfully." appears, click [OK].

Changing Default Printer Driver Settings

It is convenient to set frequently used settings as the default settings.

■ Windows PCL Printer Driver

1 Click [Start] and select [Control Panel] in [Windows System].

2 Click [View devices and printers].

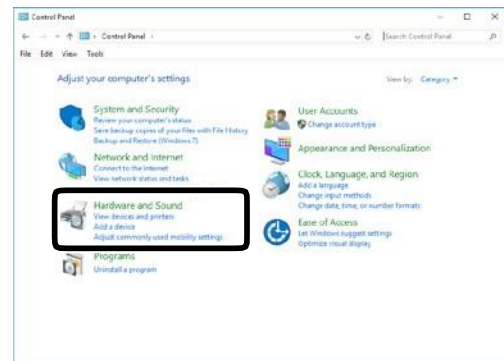

3 Right-click the [LT5C PCL6] icon, and then select [Printing preferences].

4 Change the various settings, and then click [OK].

□ Deleting or Updating a Printer Driver

Deleting a Printer Driver

■ Windows PCL Printer Driver



Note

- PC administrator privileges are required.
- Restart the computer, and then delete the driver.

1 Click [Start] and select [Control Panel] in [Windows System].

2 Click [View devices and printers].

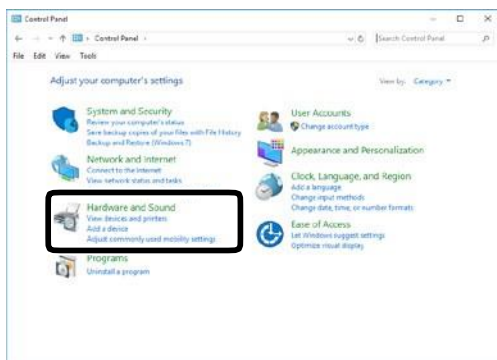

3 Right-click the [LT5C PCL6] icon, and then select [Remove device].

4 If a verification message is displayed, click [Yes].



Note

- If a message appears while the device is in use, restart the PC, and then perform steps 1 and 2 of this procedure again.

5 Select one of the icons in [Devices and Printers], and click [Print server properties] in the top bar.

6 Select the [Drivers] tab.

7 Click if [Change Driver Settings] is displayed.

8 Select the driver to be deleted, and click [Remove].

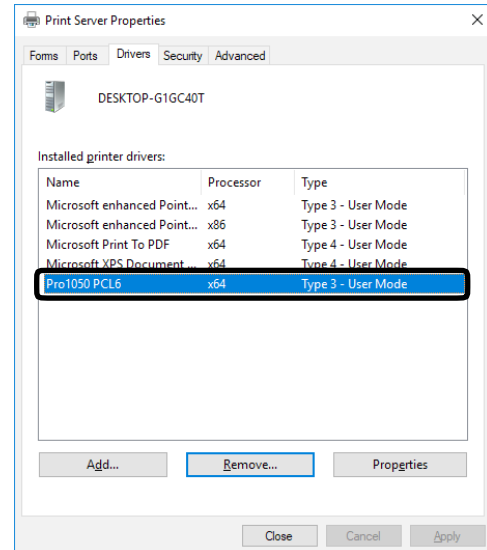

9 If a message asking whether to delete the drivers only, or the drivers and packages from the system, select to delete drivers and packages, and click [OK].

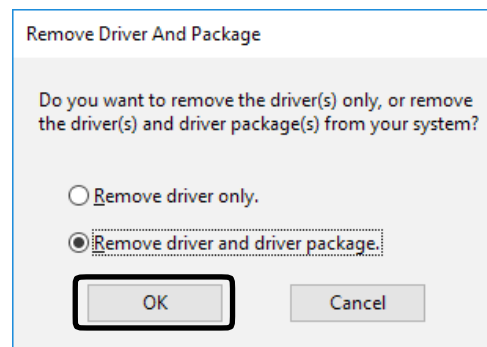

10 If a verification message is displayed, click [Yes].

11 If the [Remove Driver Package] dialog box is displayed, click [Delete]>[OK].



Note

- If you cannot cancel, restart the PC, and then perform steps 4 to 10 of this procedure again.

12 Click [OK] in the [Print server properties] dialog box.

13 Restart the PC.



Note

- Network Extension and the Color Swatch Utility installed together with the printer driver are not deleted even if the printer driver is deleted. To delete Network Extension and the Color Swatch Utility, use [Control Panel] > [Uninstall a program].

Updating a Printer Driver

For information about the latest driver versions, check the Afinia Label website.

■ Windows PCL Printer Driver



Note

- PC administrator privileges are required.

1 Download the printer driver from the Afinia Label website.

afinialabel.com/LT5Cinfo

2 Double-click the file you downloaded

3 Select the desired language, and then click [OK].



Memo

- When the "User Account Control" window is displayed, click [Yes].

4 Read the "Software License Agreement", and click [Accept].

5 Follow the instructions that appear on the screen to finish driver installation.



Memo

- Attempting to install an old version driver will cause an update screen to appear. Follow the instructions that appear on the screen.
- Updating a driver may require restarting of the computer.

6 When the [Program Compatibility Assistant] dialog appears, click [This program installed correctly].

4

Adjusting the Color

Adjusting Color with the Control Panel	100
Adjusting Color with a Printer Driver	109

Adjusting Color with the Control Panel

Correcting Color Drift Manually

The printer compensates color drift automatically according to the conditions of use. If the color drift is noticeable, you can also implement compensation manually.

- 1 Press the <Fn> key.
The numerical values input screen will be displayed.

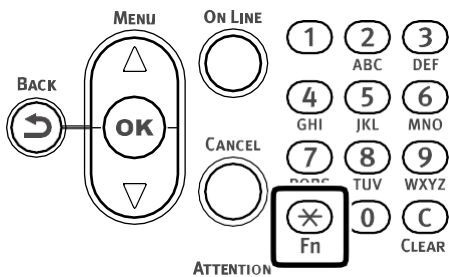

- 2 Press <3>, <0>, <1>, and press the <OK> button.

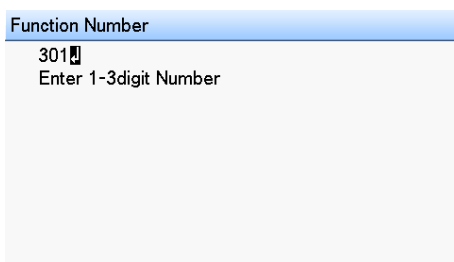

- 3 Check that [Execute] has been selected, and press the <OK> button.

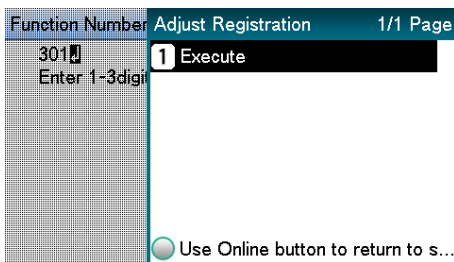

- 4 The display will return to the standby screen.

Configuring Settings for Auto Adjustment of Density and Gradation

The printer compensates density automatically according to the conditions of use. To compensate automatically, turn [On] the density compensation matching setting.

In the default factory settings, density compensation matching is implemented automatically.

- 1 Press the scroll button ▲ or ▼.

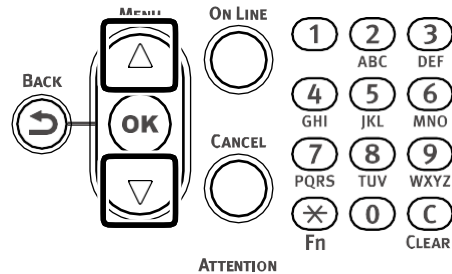

- 2 Select [Calibration], and press the <OK> button.

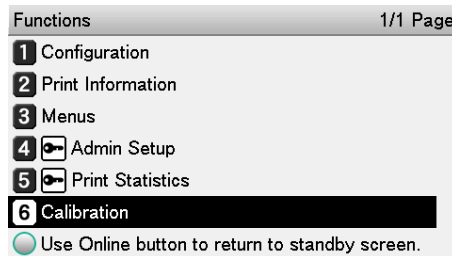

- 3 Select [Auto Density Mode], and then press the <OK> button.

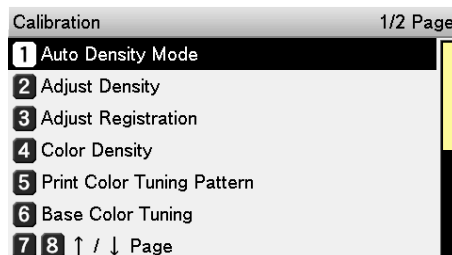

- 4 Select [On], and then press the <OK> button. Confirm there is a check mark (✓) to the left of [On].

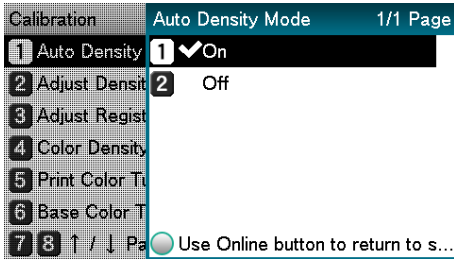

- 5 Press the <ON LINE> button to return to the standby screen.

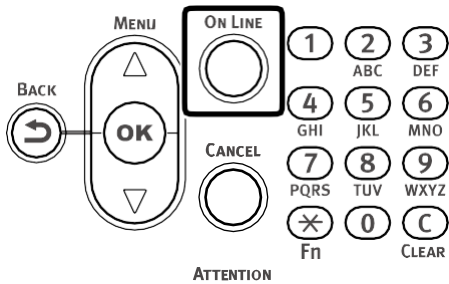

Adjusting Density Manually

The printer can implement compensation periodically using auto density compensation mode, but if the print density is noticeable, it can also be compensated manually.



- Density adjustment values are set by specifying [Cyan Density], [Magenta Density], [Yellow Density], [Black Density], and [White Density] values with the control panel.

- 1 Press the <Fn> key.

The numerical values input screen will be displayed.

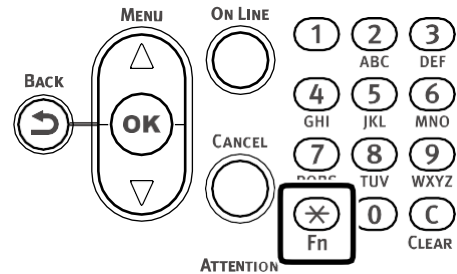

- 2 Press <3>, <0>, <0>, and press the <OK> button.

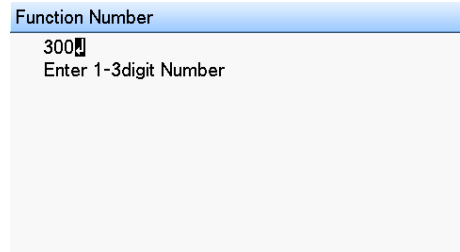

- 3 Check that [Execute] has been selected, and press the <OK> button.

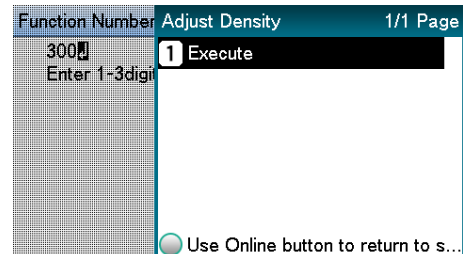

- 4 Execute density adjustment.

- The display will return to the standby screen after density adjustment is complete.

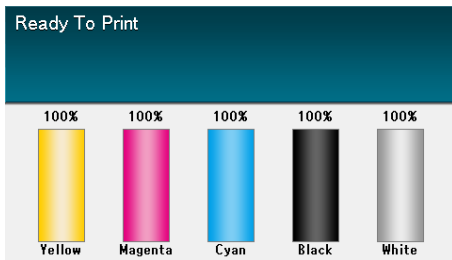

Fine Tuning Density Adjustments

You can finely adjust the densities of colors that are used as the references for density compensation.

Adjust each color separately for the parts where the density is noticeable from the print results.

This section describes the procedure for adjusting the reference density for cyan. Use the same adjustment procedure also for other colors that you wish to adjust.

• Increasing cyan after checking the print results

- Press the <Fn> key.
The numerical values input screen will be displayed.

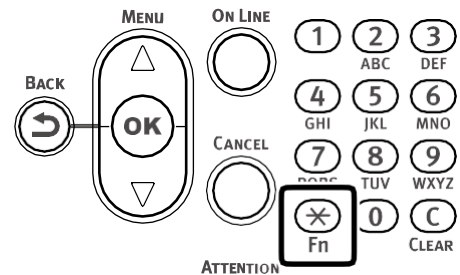

- Press <3>, <1>, <0>, and press the <OK> button.

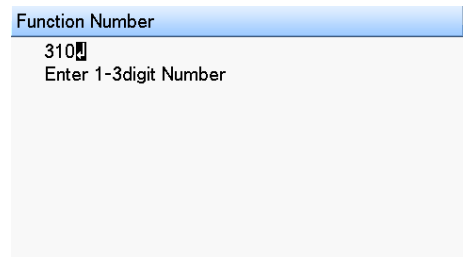

Memo

- For magenta, yellow, black, and white, use the operations below.
 - To tune magenta, press the <Fn> key, and then press the following buttons: <3>, <1>, <1>, <OK>.
 - To tune yellow, press the <Fn> key, and then press the following buttons: <3>, <1>, <2>, <OK>.
 - To tune black, press the <Fn> key, and then press the following buttons: <3>, <1>, <3>, <OK>.
 - To tune white, press the <Fn> key, and then press the following buttons: <3>, <1>, <4>, <OK>.

- 3** Press the scroll button ▲ or ▼ to specify a value that is larger than the current value, and then press the <OK> button.

Confirm there is a checkmark (✓) to the left of the selected value.

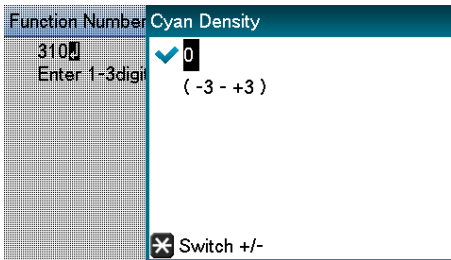

Memo

- Select +1 to +3 to make density darker, or -1 to -3 to make it lighter.

- 4** Press the <ON LINE> button to return to the standby screen.

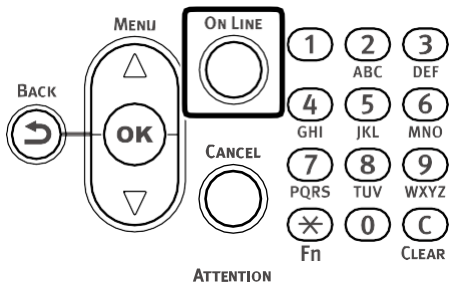

- 5** Press the <Fn> key, and then press <3>, <0>, <0>, <OK>.

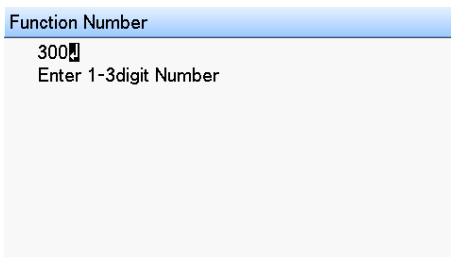

- 6** Check that [Execute] has been selected, and press the <OK> button.

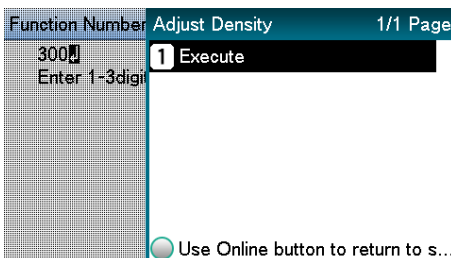

- 7** The display will return to the standby screen.

- 8** Print.

If you are not satisfied with the density, repeat steps 1 to 6 of this procedure.

Adjusting Color Balance (Density)

The printer can implement compensation periodically using auto density compensation mode. However, you can implement this adjustment when you want to adjust the gray balance of the halftones, which is not sufficiently adjusted by the auto density compensation.

Note

- The densities of the colors are mutually dependent on each other, so you will need to repeat adjustment several times until the desired color balance is achieved.
- The results of the basic [Base Color Tuning] are reflected in the settings in [Fine Color Tuning]. Consequently, if the [Fine Color Tuning] are adjusted manually, these settings will be reset, so be careful. However, the [Black Tuning] settings are not reset.

1 Print a color tuning pattern.

- (1) Press the <Fn> key. The numerical values input screen will be displayed.

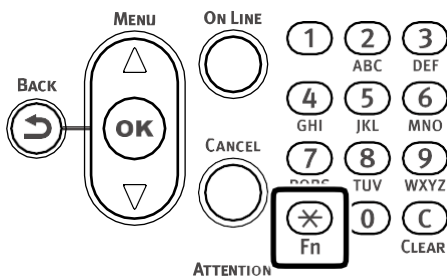

- (2) Press <3>, <0>, <2>, and press the <OK> button.

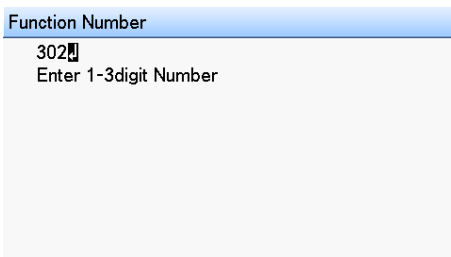

- (3) Check that [Execute] has been selected, and press the <OK> button.

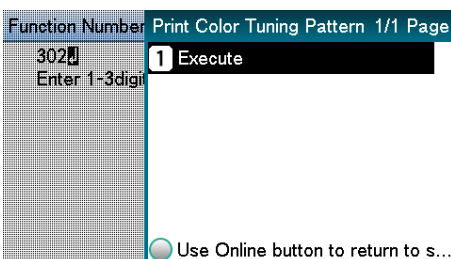

- (4) The color tuning pattern will be printed.

2 Use the print results for the color tuning pattern to check the current color balance.

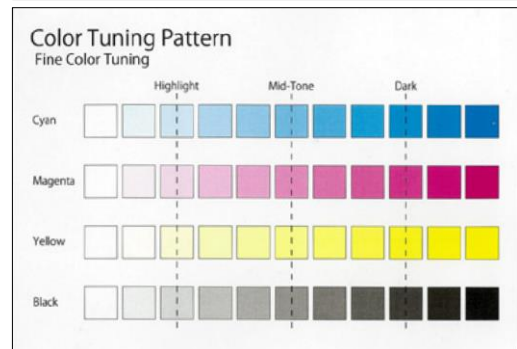
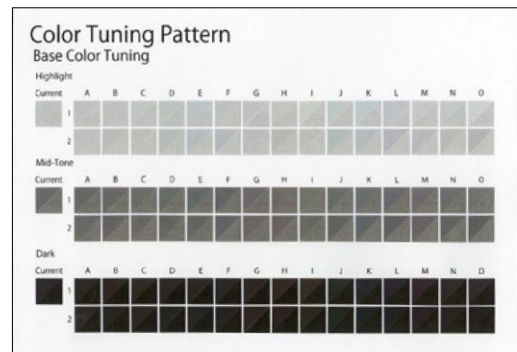

- (1) Check the area to be referenced using "Base Color Tuning". Check the numbers (A1,2 to O-1,2) of the pattern that seems the most similar to the adjacent CMY mixed colors part and single color K part from among the patterns distributed in the "Highlight", "Mid-Tone", or "Dark" areas.

Memo

- If the pattern that seems most similar to the adjacent CMY mixed colors part and single color K part in the "Highlight", "Mid-Tone", or "Dark" areas matches the "Current" on the left of the colortuning pattern, the color balance is normal and does not require adjustment.

3 Use the print results for the color tuning pattern to adjust the color balance.

- (1) Press the scroll button ▲ or ▼.

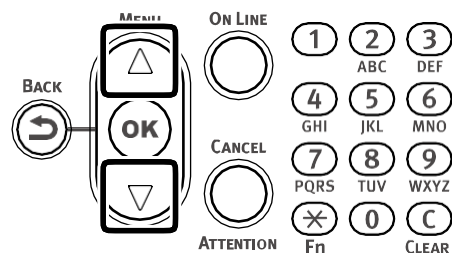

- (2) Select [Calibration], and press the <OK> button.

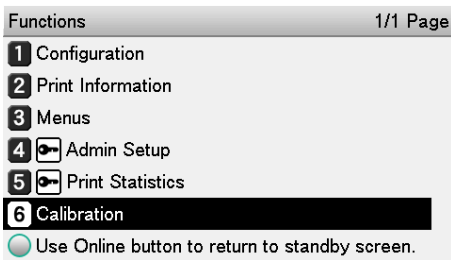

- (3) Select [Base Color Tuning], and press the <OK> button.

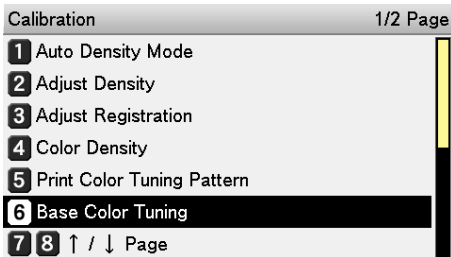

- (4) Specify the number of the desired square in the "Highlight" area of the pattern, and then press the <OK> button.

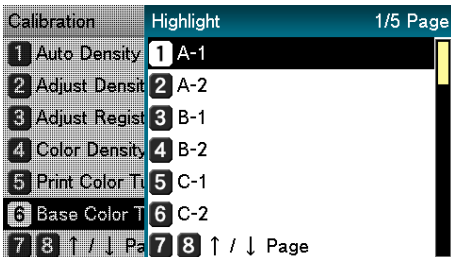

- (5) Specify the number of the desired square in the "Mid-Tone" area of the pattern, and then press the <OK> button.

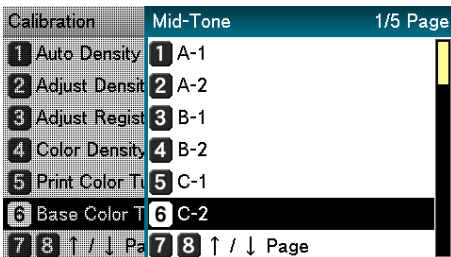

- (6) Specify the number of the desired square in the "Dark" area of the pattern, and then press the <OK> button.

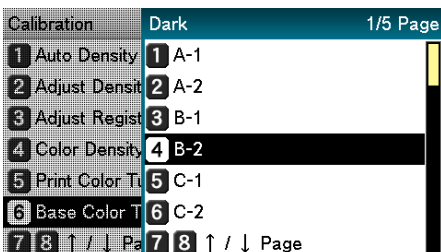

- (7) The pattern number specified in each area will be displayed.

If the pattern number is correct, select [Yes], and press the <OK> button.

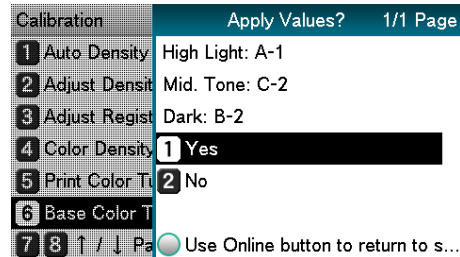

- To respecify the pattern number select [No] to return to the "Calibration" screen.

- (8) Select [Return], and press the <OK> button to return to the standby screen.

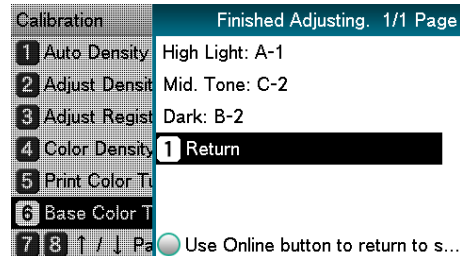

- If the desired color balance is not obtained even after [Base Color Tuning], adjust the CMY color balance manually using the procedure under [Adjusting the color balance]. For color balance fine tuning, see "Fine-tuning Color Balance" (P.106).
- If the overall tone is still too bright or too dark even after implementing [Base Color Tuning], adjust the black tone manually using [Fine Color Tuning], and then implement [Basic color Tuning] again. To brighten the overall tone, adjust the black tone in [Fine Color Tuning] in the - direction, and to darken the overall tone, adjust the black tone in [Fine Color Tuning] in the + direction.

4 Check the color balance adjustment results.

- (1) Print the color tuning pattern.
- (2) Use the print results for the color tuning pattern to check the adjusted results.

If the pattern that seems most similar to the adjacent CMY mixed colors part and single color K part in the "Highlight", "Mid-Tone", or "Dark" areas matches the "Current" on the left of the color tuning pattern, the color balance adjustment is complete.

Repeat steps 1 through 3 of this procedure in accordance with the results of your pattern check.

Fine-tuning Color Balance

The printer can implement compensation periodically using auto density compensation mode. However, you can implement this adjustment when you want to finely adjust the gray balance of the halftones, which is not sufficiently adjusted by the auto density compensation.



Note

- The densities of the colors are mutually dependent on each other, so you will need to repeat adjustment several times until the desired color balance is achieved.

1 Print a color tuning pattern.

- (1) Press the <Fn> key.

The numerical values input screen will be displayed.

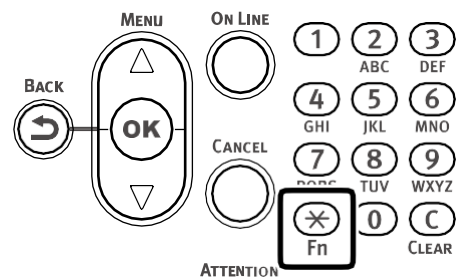

- (2) Press <3>, <0>, <2>, and press the <OK> button.

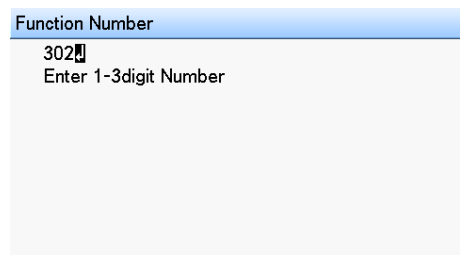

- (3) Check that [Execute] has been selected, and press the <OK> button.

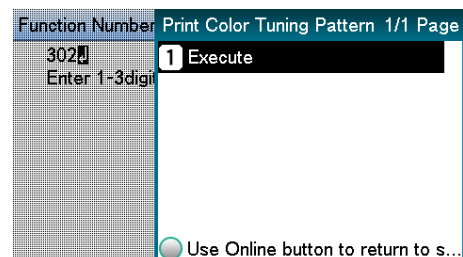

- (4) The color tuning pattern will be printed.

2 Use the print results for the color tuning pattern to check the current color balance.

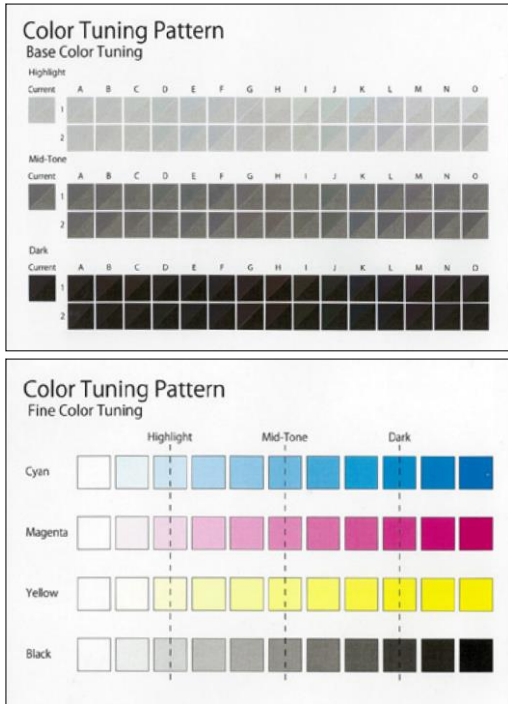

(1) Check the area to be referenced using "Fine Color Tuning".

The color tuning pattern blocks are arranged in four rows of 11 columns. The four rows are printed with the following colors, from top to bottom: [Cyan], [Magenta], [Yellow] and [Black].

The 11 columns represent color tone, and vertical broken lines are labeled as [Highlight], [Mid-Tone], and [Dark].

3 Use the print results for the color tuning pattern to adjust the color balance.

If you are adjusting the color balance, use the control panel to specify the shade (Highlight, Dark, and Mid-Tone) of each color.

This section explains the procedure for slightly darkening the cyan highlights. Adjust the colors other than cyan in the same way.

(1) Press the scroll button ▲ or ▼.

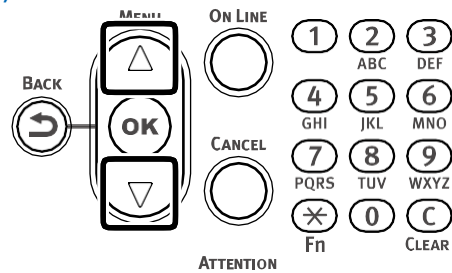

(2) Select [Calibration], and press the <OK> button.

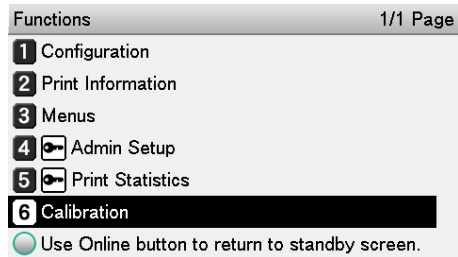

(3) Select [Fine Color Tuning], and press the <OK> button.

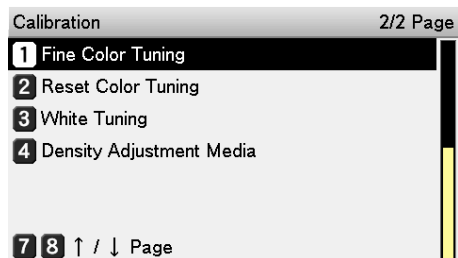

(4) Select [Cyan Tuning], and press the <OK> button.

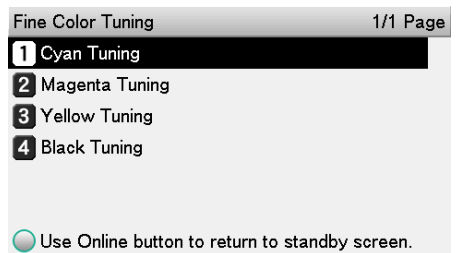

- (5) Select [Highlight], and press the <OK> button.

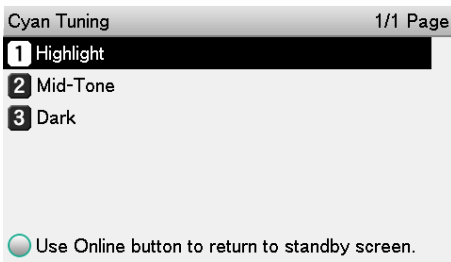

- (6) Specify a larger value than the current set value, and press the <OK> button. Confirm there is a check mark (✓) to the left of the specified value.

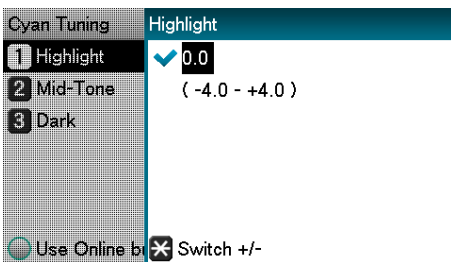

 Memo

- Select +0.1 to +4.0 to make density slightly darker, or -0.1 to -4.0 to make it slightly lighter. Note, however, that the black adjustment ranges are +0.1 to +3.0 and -0.1 to -3.0.

- (7) Press the <ON LINE> button to return to the standby screen.

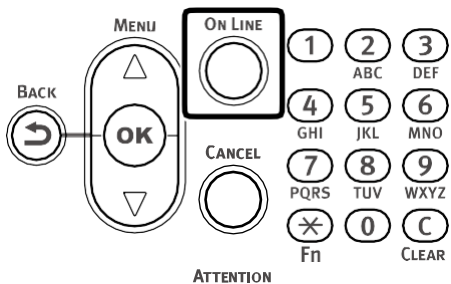

4 Check the color balance adjustment results.

- (1) Print the color tuning pattern.
- (2) Use the print results for the color tuning pattern to check the adjusted results.

Repeat steps 1 through 3 of this procedure in accordance with the results of your pattern check.

□ Adjusting Color with a Printer Driver

Color Matching

What Is Color Matching?

It is important to manage the work processes from data creation to output based on methods with color consistency. For example, scanners, digital cameras, and monitors, and other devices express the blending ratio to which the light of red, blue, and green (three colors) have been added to black as values over the RGB color space (additive mixture of colors).

Meanwhile, printers express the blending ratio of the four toner colors cyan, magenta, yellow, and black relative to white (white light), with the three reflected colors red, blue, and green excluded as values in the CMYK color space (subtractive mixture of colors).

The RGB color space and CMYK color space are color spaces dependent on the machine used, and so when converting color spaces, the colors will be different from the reproduced colors unless individual machine characteristics are taken into consideration.

To maintain color consistency from data creation to output, it is necessary to consider the color differences by device when converting colors. This process is called "color matching". The program that implements the color matching is called the "color management system" (CMS).

The printer can use either printer driver color matching or application color matching.



Note

- Even if you are using color matching, the printed colors may appear dark compared to the colors on the monitor. This is because the range of colors that can be reproduced by the device is narrower than the range of colors that can be reproduced by the monitor, so even if color matching is used, the vivid colors on the monitor cannot be reproduced.

Color Matching (Automatic)

The procedure below performs recommended color matching for general documents. Generally use the settings shown here.

■ Windows PCL Printer Driver

- 1 Open the file to be printed.
- 2 On the [File] menu, select [Print].
- 3 Click [Preferences] (or [Properties]).
- 4 In "Color" on the [Color] tab, select [Automatic], and then click [OK].

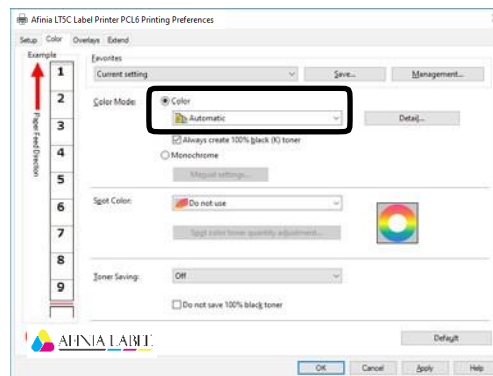

- 5 Print.

Simple Color Matching (Simple Adjustment)

Color matching is used on a printer for reproduction of the RGB colors required to print from word processor, spreadsheet, presentation, and other similar software.

Color matching is implemented using a special accelerator (ASIC) that is built into the printer. When converting RGB color space print data to the printer CMYK color space, color matching processing is applied.



Note

- In the case of a Windows PCL printer driver, color matching is not applied even if [Automatic] or [Simple Adjustment] is selected for the CMYK color space print data. In this case, select "Graphic Pro".
- If you are installing ICC profile in Windows, click [Advanced Setup] in the [Layout] tab, and then select [Disable ICM] in [ICM Methods].

■ Setup Items

- [RGB Color Setting]
 - Specifies the method for expressing the colors processed using color matching.
 - Monitor - Auto
 - During color matching, represents color by the most ideal method suited to the document to be printed, emphasizing compatibility with the monitor (color temperature 6500 K). Normally use this setting.
 - Monitor - Perceptual
 - During color matching, represents the color by the method emphasizing the gradation suiting the natural image of the photograph and compatibility with the monitor (color temperature 6500K).
 - Monitor - Vivid
 - During color matching, represents the color by the method emphasizing the vividness suiting the images and text, and compatibility with the monitor (color temperature 6500K).
 - Monitor - light
 - During color matching, represents the color by the method emphasizing the gradation suiting the natural image of the photograph and compatibility with the monitor (color temperature 9300K).
 - Adobe RGB
 - Specify if you are using an input device with AdobeRGB color characteristics.
 - sRGB
 - The sRGB colors within the printer's color gamut are printed without any modification. Only colors that fall outside the printer's color gamut are matched with the outer shell. Suitable for matching specific colors.
- [Black Finish]
 - Sets the black finish when printing in color. Normally use Auto as is.

Color Matching (Graphic Pro)

Graphic Pro is the optimal choice for use with DTP software.

It lets you specify simulation printing for any CMYK output device.

To use an ICC profile of an I/O device for color matching, you need to register the ICC profile to the device beforehand.

■ Windows PCL Printer Driver

- 1 Open the file to be printed.
- 2 On the [File] menu, select [Print].
- 3 Click [Preferences] (or [Properties]).
- 4 On the [Color] tab, click [Color], then select [Graphic Pro], and then click [OK].

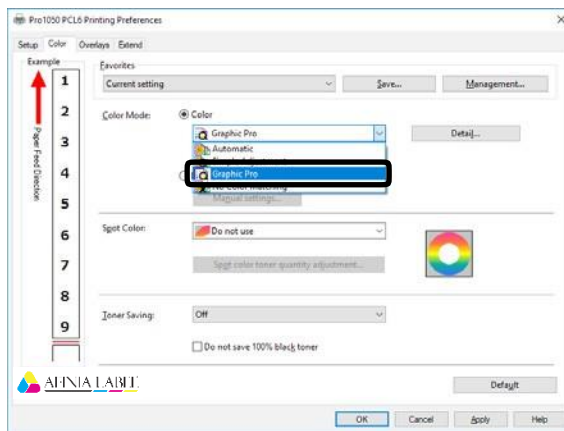

Pro1050 PCL6 Printing Preferences

- 5 Print.

■ Windows PCL Printer Driver

- 1 Open the file to be printed.
- 2 Select [Print] in the [File] menu.
- 3 Click [Preferences] (or [Properties]).
- 4 On the [Color] tab, click [Color], select [Automatic] or [Simple Adjustment], and then click [OK].

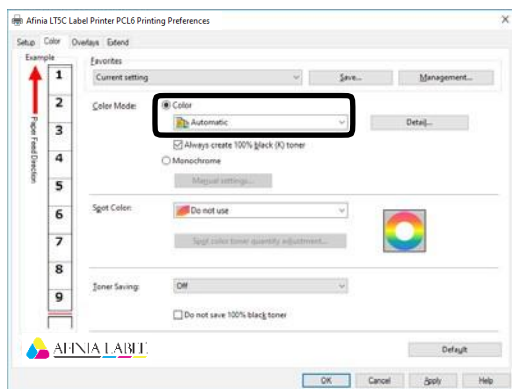

- 5 Print.

Color Matching (No Color Matching)

Prints using the specified colors as is, without implementing color matching using the printer drivers or device.

Select if implementing color matching using an application.

■ Windows PCL Printer Driver

- 1 Open the file to be printed.
- 2 On the [File] menu, select [Print].
- 3 Click [Preferences] (or [Properties]).
- 4 On the [Color] tab, click [Color], then select [No Color Matching], and then click [OK].

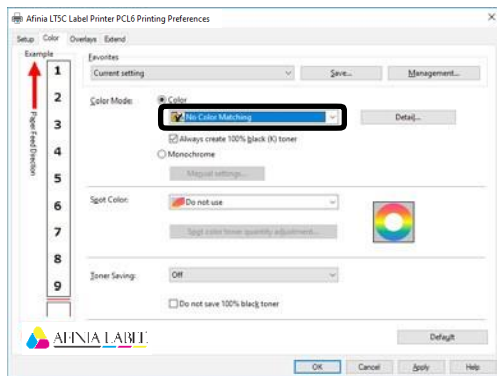

- 5 Print.

Changing the Black Finish

The finish for the black parts will be changed when printing in color. This can be used when the printer driver's color mode setting is [Simple Adjustment] or [Graphic Pro].

■ Setup Items

- Black Finish
 - Auto
 - Creates black using the optimum methods according to the document to be printed. This setting can be selected only when the color mode is set to [Simple Adjustment]. This setting cannot be configured on the Graphic Pro.
 - Composite Black(CMYK)
 - Synthesizes black using cyan, magenta, yellow, and black toner. The black is close to brown. Ideal for photos.
 - True Black (K)
 - Prints black using black toner only. Ideal for diagrams and documents. When printing photos, the dark parts are blackish.
 - Pure Black Text/Graphics (Graphic Pro Only)
 - If black defined using the RGB color space for text and graphics (R=0, G=0, B=0) or black defined using the CMYK color space (C=0, M=0, Y=0, K=100%) is specified, this setting specifies whether printing should use black (K) toner only.
- ON
 - Prints the text and graphics specified as black using black (K) toner only.
- OFF
 - Text and graphics specified as black are synthesized using either black (K) toner only or CMYK depending on the profile specified by color matching.

■ Windows PCL Printer Driver

- 1 Open the file to be printed.
- 2 On the [File] menu, select [Print].
- 3 Click [Preferences] (or [Properties]).
- 4 On the [Color] tab, select [Simple Adjustment] or [Graphic Pro], and then click [Detail].
- 5 In the [Black Finish] section, select the black finishing method. In the [Graphic Pro] mode, also select ON or OFF for [Pure Black Text/Graphics], and then click [OK].

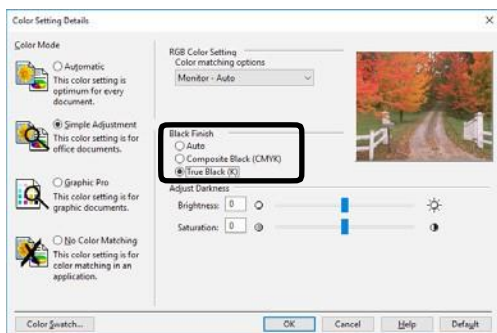

- 6 Print.

Monochrome (Black and White) Printing

The color data is printed using grayscale (shades of black and white) without touching the print data.



Note

- If implementing color printing after printing by specifying "Monochrome", a delay may occur depending on the temperature adjustment of the fuser unit.



Memo

- Even if the cyan (blue), magenta (red), yellow print cartridge life has been reached, monochrome printing using only black can be done by specifying "Monochrome".
- Refer to "Printing Using the Specified Print Cartridge Only (Lift Up)" (P.80) regarding printing with black only.
- For information about roll paper, see "Roll Paper Specifications" (P.12).

■ Windows PCL Printer Driver

- 1 Open the file to be printed.
- 2 Select [Print] in the [File] menu.
- 3 Click [Preferences] (or [Properties]).
- 4 On the [Color] tab, select [Monochrome]. Adjust lightness and darkness as required.

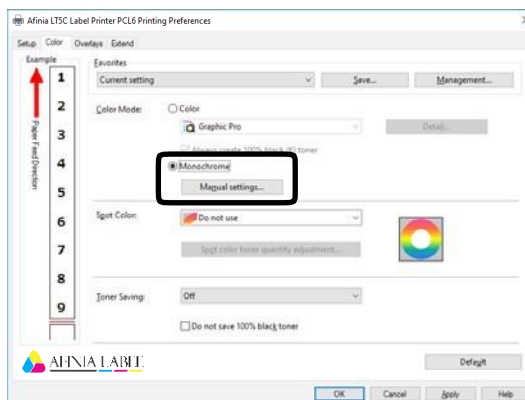

- 5 Print.

Suppressing White Lines Between Text and the Background (Black Overprint)

If you are imaging 100% black text on a colored background, you can print (overprint) by overlaying the text and background parts. Set if there are gaps such as white lines, etc., in the borders between the text and background.



Note

- Not usable with some applications.
- Black overprint cannot be used if the text is not 100% black, the text has been rendered as graphics by extracting the outlines, or if the text is an image.
- If the background color is dark (toner layer thickness exceeds 240%), toner may not be fixed completely. For example, if printing 100% black text on backgrounds of 50% cyan, 50% magenta, and 50% yellow, the toner layer thickness is $50+50+50+100=250\%$, which exceeds 240%.

■ Windows PCL Printer Driver

- 1 Open the file to be printed.
- 2 Select [Print] in the [File] menu.
- 3 Click [Preferences] (or [Properties]).
- 4 On the [Extend] tab, click [Advanced].
- 5 Select [Overprint Black]. Next, for [Settings], select [On], and then click [OK].

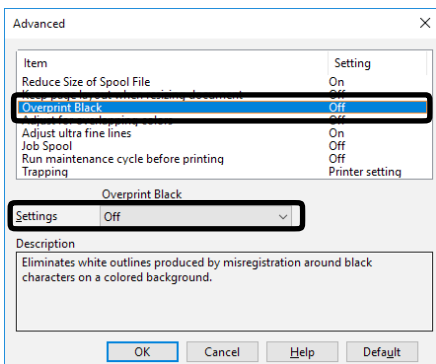

- 6 Print.

Correcting for Print Misalignment (Trapping)

Use if there are white or colored lines between two overlapping objects due to print misalignment.

■ Windows PCL Printer Driver

- 1 Open the file to be printed.
- 2 Select [Print] in the [File] menu.
- 3 Click [Preferences] (or [Properties]).
- 4 On the [Extend] tab, click [Advanced].
- 5 Select [Trapping]. Next, select the misalignment correction method with [Settings], and then click [OK].

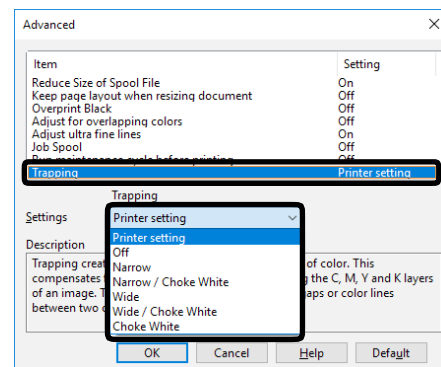

- 6 Print.

Simulating Print Results

The printer adjusts CMYK color data to simulate the characteristics of ink, such as that used in offset printing.

The ICC profiles registered as standard are described below.

- RGB Profiles
 - sRGB
 - AdobeRGB
- CMYK Input Profiles
 - SWOP
 - ISO Coated
 - Japan Color
 - JMPA



Note

- Enabled when [Color Mode] is set to either [Simple Adjustment] or [Graphic Pro].

■ Windows PCL Printer Driver

- 1 Open the file to be printed.
- 2 Select [Print] in the [File] menu.
- 3 Click [Preferences] (or [Properties]).
- 4 On the [Color] tab, click [Detail], and then select [Graphic Pro].
- 5 Select [Printer Simulation], and then use the list under [Simulation Target Profile] to select the ink characteristics you want to simulate.

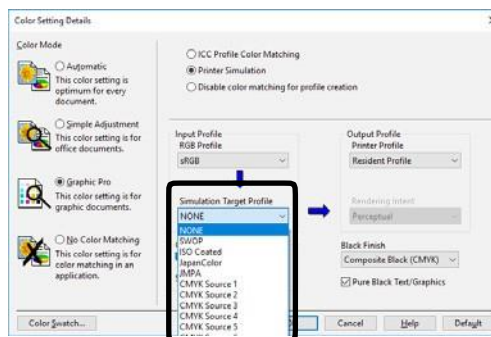

- 6 Click [OK].
- 7 Print.

5

Spot Color Printing Setup

Printer Driver Spot Color Function List	118
Printing on Color Papers.....	119
Fine-Tuning White Shading	121

 **Note**

- The examples in this chapter use Windows WordPad for explanations. Depending on the application, the screens and operations procedures may differ.
- For detailed explanations of the printer driver and utility setup items, see "Online Help".
- Due to printer driver and utility version upgrades, actual operations may be different from the descriptions in this manual.

Printer Driver Spot Color Function List

This section explains the Spot Color toner functions in the printer drivers.

Windows PCL Printer Driver

Click the [Color] tab to display the screen for setting the spot color toner.

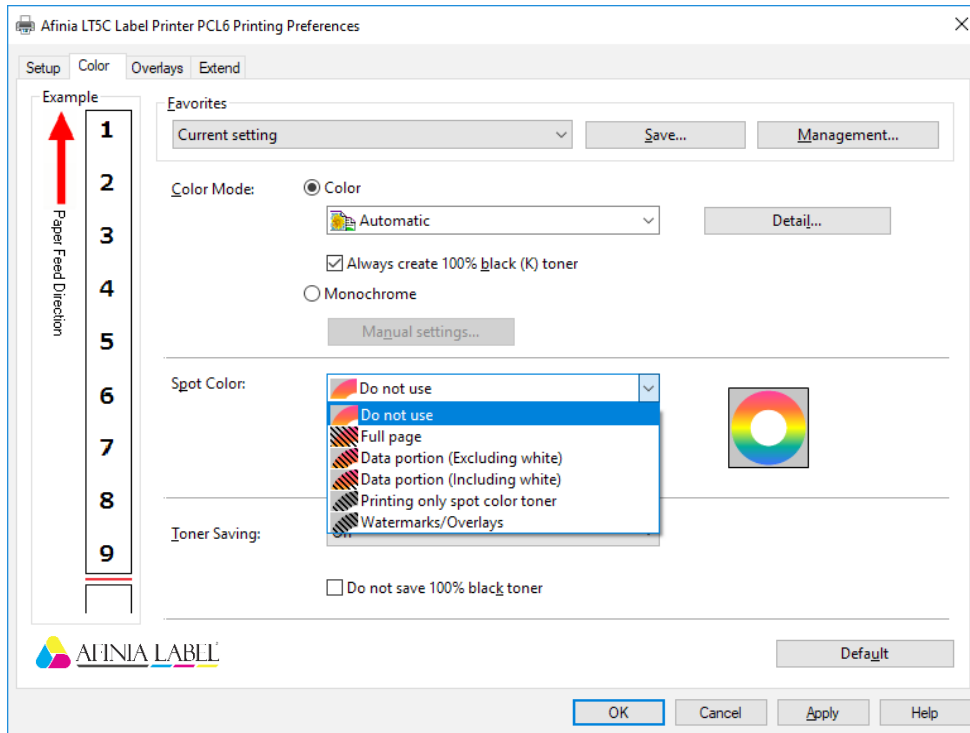

Item		Description
Usage Method	Do not use	Prints without using white toner.
	Full page	Uses white toner for the entire page being printed.
	Data portion (Excluding white)	Uses white toner for all data parts that do not include white parts.
	Data portion (Including white)	Uses white toner for all data parts that include white parts.
	Printing only spot color toner	Prints with white toner only.
	Watermarks/Overlays	Prints the selected watermark and overlay with white toner.
Spot color toner quantity adjustment	0 to 100	Adjusts the amount of white toner used while printing.

□ Printing on Color Papers

Usable Color Papers

Use color paper that satisfies the following conditions.

- Pigment or ink used to color the paper heat-resistant to 230°C
- E-photo printer paper with the same paper characteristics as plain paper

Printing Using White Toner Only

Printing text and illustrations using only white toner on color paper.

Before printing, check that the white print cartridge has been mounted to the device, and that white toner has been selected using the printer drivers.



- If you specify "Print Only with Spot Color" and lift up all the other colors of cartridges, you can print with only spot colors, even if one of the black, cyan, magenta, or yellow print cartridges has reached the end of its service life.

■ Windows PCL Printer Driver

- 1 Open the file to be printed.
- 2 Select [Page Setup] in the [File] menu.
- 3 Select the paper size and print orientation, and then click [OK].
- 4 Select [Print] in the [File] menu.
- 5 Click [Preferences] (or [Properties]).
- 6 Use [Media Type] to select the paper type.
- 7 Use [Media Weight] to select an appropriate value.
- 8 Click the [Color] tab.

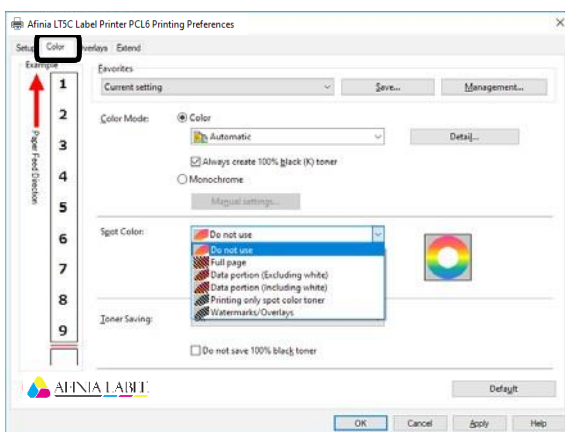

- 9 For [Usage Methods], select [Printing only spot color toner], and then click [OK].

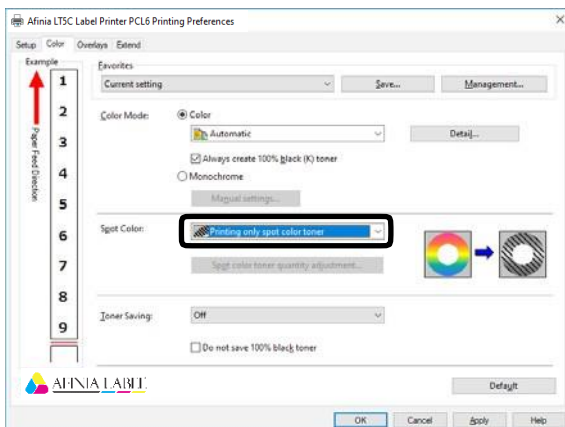

- 10 Click [Print] in the "Print" screen to print.

Printing White Under Color

When printing on color paper, print a base with white toner, and then print in color on top of that.

■ Windows PCL Printer Driver

- 1 Open the file to be printed.
- 2 Select [Page Setup] in the [File] menu.
- 3 Select the paper size and print orientation, and then click [OK].
- 4 Select [Print] in the [File] menu.
- 5 Click [Preferences] (or [Properties]).
- 6 Use [Paper settings] to select the paper type.
- 7 Click the [Color] tab.
- 8 For the [Spot Color] setting, select one of the following: [Full page], [Data portion (Excluding white)], [Data portion (Including white)], or [Watermarks/Overlays].
- 9 Click [OK].
- 10 Click [Print] in the "Print" screen to print.

□ Fine-Tuning White Shading

Finely adjust the shade for each white highlight, dark, mid-tone gradation using the printer control panel.

Here, we will show the procedure for slightly darkening white highlights.

1 Press the scroll button ▲ or ▼.

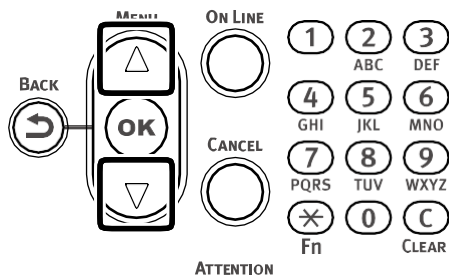

2 Select [Calibration], and press the <OK> button.

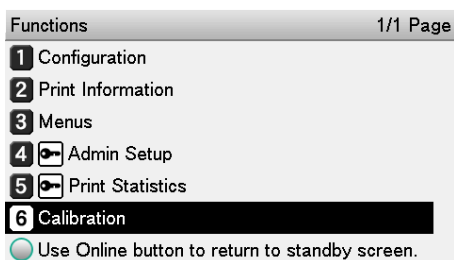

3 Select [White Tuning], and then press the <OK> button.

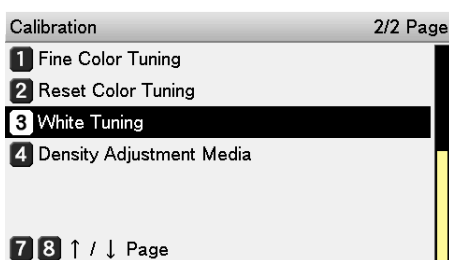

4 Select [Highlight], and press the <OK> button.

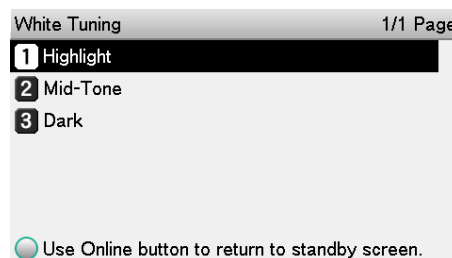

5 Specify a value that is larger than the current set value, and then press the <OK> button. Confirm there is a check mark (✓) to the left of the specified value.

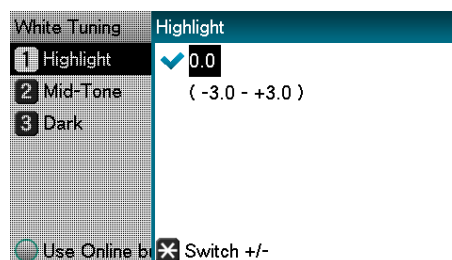

Memo

- A larger value represents darkening, while a smaller value represents lightening.

6 Press the <ON LINE> button to return to the standby screen.

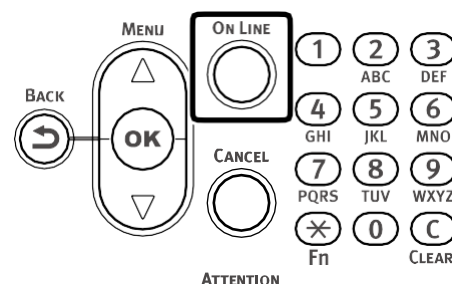



Network Settings

Initializing Network Settings	124
Using DHCP	125
IPv6	127

□ Initializing Network Settings



Note

- Implementing this operation will initialize all network settings.

1 Press the scroll button  or .

2 Select [Admin Setup], and then press the <OK> button.

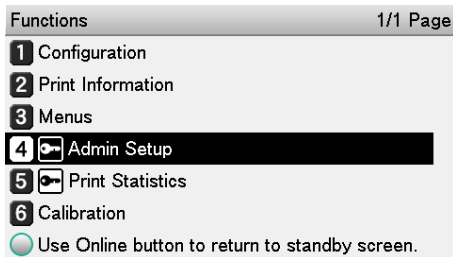

3 Enter the administrator password, and then press the <OK> button.



Memo

- The factory default setting of the administrator password is [999999].

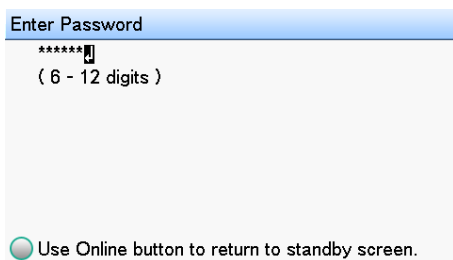

4 Select [Network Setup], and then press the <OK> button.

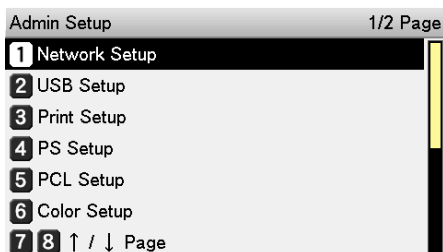

5 Select [Network Factory Defaults], and then press the <OK> button.

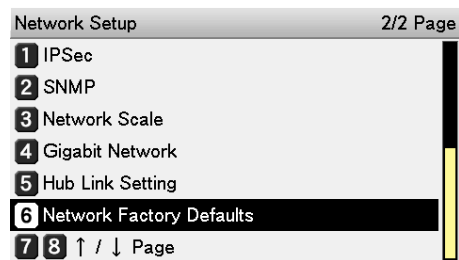

6 When [Execute] appears, press the <OK> button.

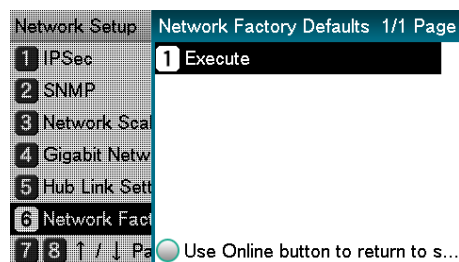

7 Initialization is executed, and the display returns to the standby screen.

□ Using DHCP

IP addresses can be acquired from a DHCP server.



Note

- PC administrator privileges are required for the setup.
- Incorrectly allocating the IP address may cause major malfunctions such as crashing of the network. Thoroughly consult the network administrator before making the settings.

To use the device in a DHCP environment, select [Auto] as the IP address setting method.

Also note that [Auto] is the IP address setting method under factory default settings, so performing this procedure is normally not necessary.

- 1** Press the scroll button ▲ or ▼.

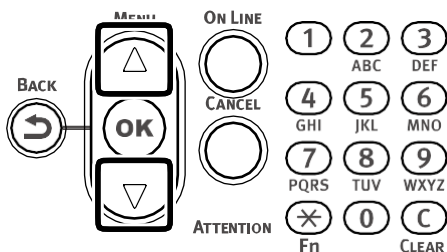

Select [Admin Setup], and then press the <OK> button.

2

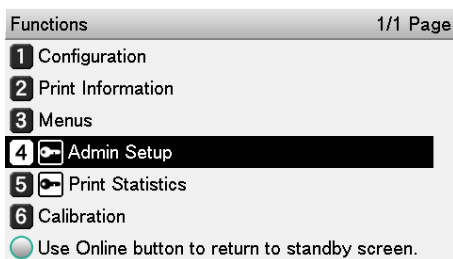

- 3** Enter the administrator password, and then press the <OK> button.



Memo

- The factory default setting of the administrator password is [999999].

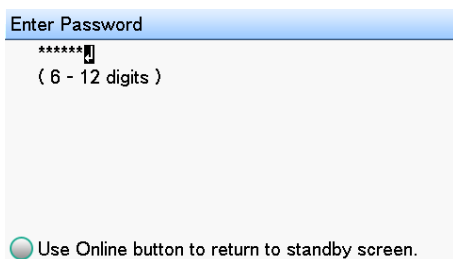

- 4** Select [Network Setup], and then press the <OK> button.

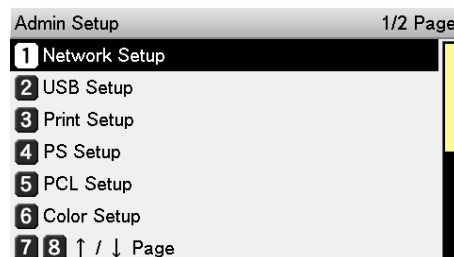

- 5** Select [IP Address Set], and then press the <OK> button.

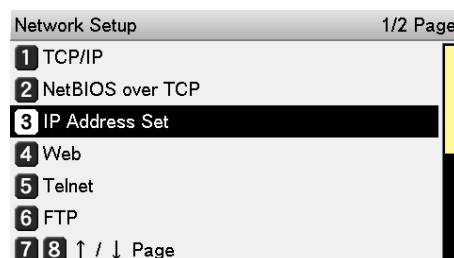

- 6** Select [Auto], and then press the <OK> button.

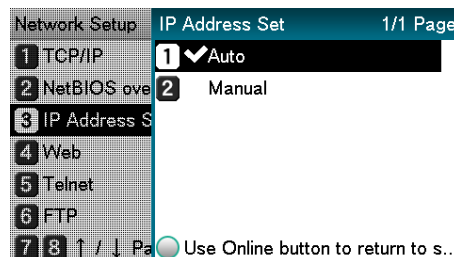

- 7** Press the <ON LINE> button to return to the standby screen.

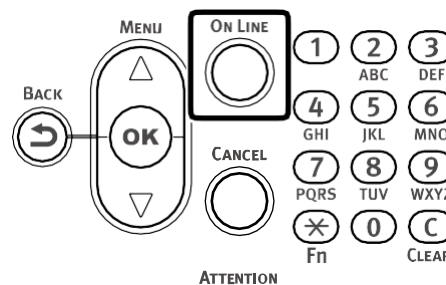

■ To use the printer in a BOOTP environment

To use the printer in a BOOTP environment, select [BOOTP] as the IP address setting method.

- 1 Access the printer web page and log in as an administrator.
- 2 Select [Admin Setup].
- 3 Select [Network Setup] > [TCP/IP] > [Change Settings] > [Get IP address automatically (BOOTP)].
- 4 Click [Submit].



- Refer to "Using a Web Browser to Configure the Network Setup" (P.141) regarding the printer web page.

□ IPv6

This printer is compatible with IPv6, and the IPv6 address is acquired automatically. IPv6 addresses cannot be set manually.

The device is compatible with the following protocols.

- Printing:
 - LPR
 - IPP
 - RAW (Port9100)
 - FTP
- Setup:
 - HTTP
 - SNMPv1/v3
 - Telnet

Checking the IPv6 Address

IPv6 addresses are allocated automatically.

- 1 Access the printer web page and select [View information].



Memo

- Refer to "Using a Web Browser to Configure the Network Setup" (P.141) regarding the printer web page.

- 2 Select [Network] > [TCP/IP].



Memo

- If all the global addresses are displayed as "0", it is possible an error has occurred in the router being used.



Reference

- Press the scroll button ▲ or ▼, and then select [Print Information] > [Configuration] to check the IPv6 address using the configuration report. For reports and information about how to print them, see "Printing Configuration Information" (P.130).



Viewing Machine Information

Printing Configuration Information.....	130
Checking the Print Count.....	138

□ Printing Configuration Information

Printable Report List

List Name	Description	Reference pages
Configuration	Prints the table of all menu category items and the current settings. Further, the advanced printer settings are also printed in the page header.	Page 131
Demo Page	Prints the demo print data stored in the printer.	Page 132
File List	Prints the file list.	Page 52
Usage Report	Prints the total print results.	Page 133
Error Log	Prints the errors detected and saved by the printer.	Page 133
Color Profile List	Prints the color profile list.	Page 134
Color Adjustment Pattern	Prints the patterns to match the shading characteristics.	Page 104 Page 106
User Media List	Prints the user media list.	Page 135
Test Print-1	Prints the patterns for analyzing the print quality.	Page 135
Test Print-2	Prints the patterns for analyzing CYMK print quality.	Page 135
Test Print-3	Prints the patterns for analyzing the status of the print cartridges.	Page 135
Test Print-4	Prints the patterns for analyzing print quality of the spot colors.	Page 135
Cleaning Page	Prints the toner-free white sheet to remove dirt from the surface of the fuser belt in the fuser unit.	Maintenance Guide

- Paper is cut at a fixed length when printing a report, so do not use die-cut label paper.
- To attain the full benefit of the report printing function, load paper that is 130 mm wide.
- Printing is canceled if a print cartridge for a color that is required for report printing is not lifted down.

Printing Printer Setup Lists

Configuration

Print the device information.

Print to see the remaining quantity of consumables and other set values such as IP addresses and MAC addresses, and to check whether the printer is operating correctly, etc.

To print

- 1 Press the <Fn> key.
The numerical values input screen will be displayed.

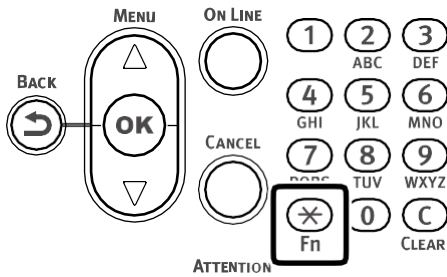

- 2 Press <1>, <0>, <0> (function numbers), and then press the <OK> button.

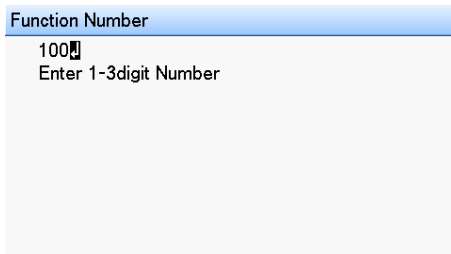

- 3 Confirm that [Execute] is selected, and then press the <OK> button.

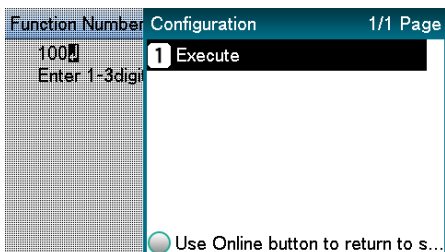

Printing result samples

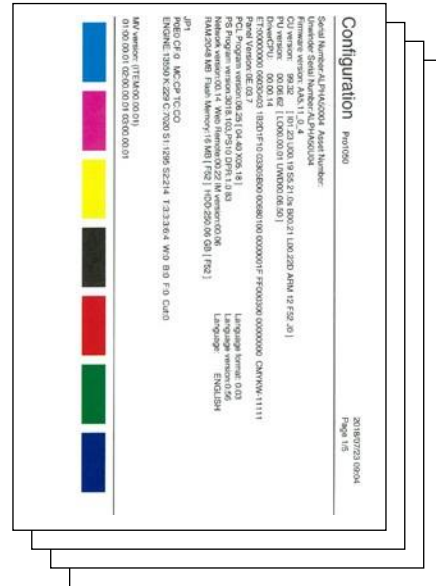

Printing Printer Information Lists

Demo Page

Prints demonstration pages.

■ To print

1 Press the scroll button ▲ or ▼.

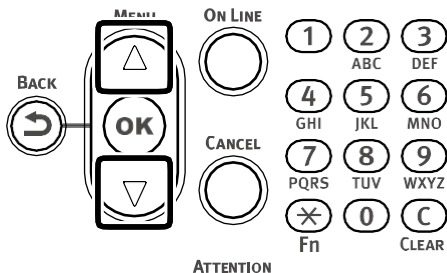

2 Select [Print Information], and then press the <OK> button.

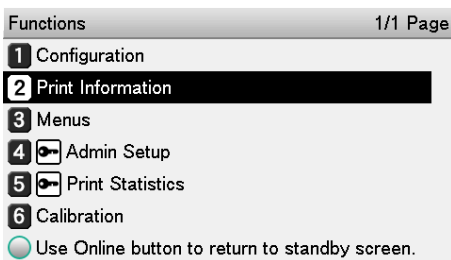

3 Select [Demo Page], and then press the <OK> button.

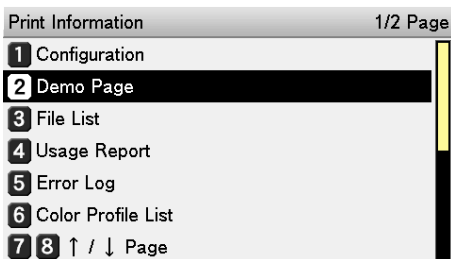

4 When [DEMO1] appears, select one of the items to be printed, and then press the <OK> button.

5 Confirm that [Execute] is selected, and then press the <OK> button.

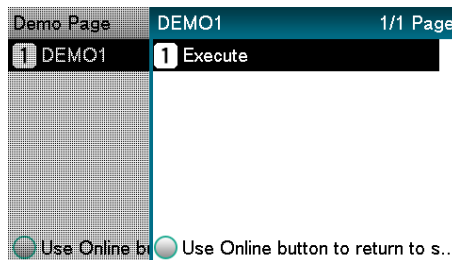

Error Log

Prints the history of the errors that have occurred in the device.

To print

- 1 Press the <Fn> key.
The numerical values input screen will be displayed.

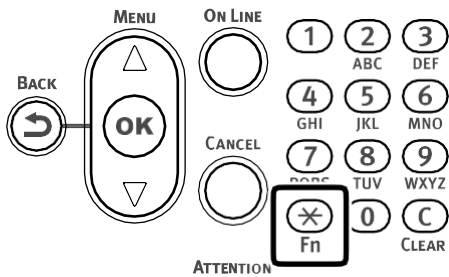

- 2 Press <1>, <0>, <3> (function numbers), and then press the <OK> button.

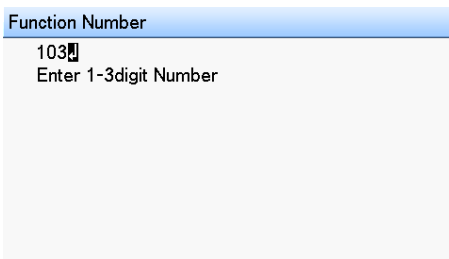

- 3 Confirm that [Execute] is selected, and then press the <OK> button.

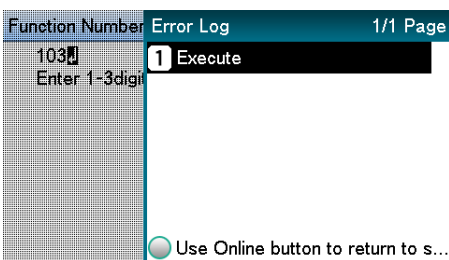

Usage Report

Prints the total print results.



- Not displayed if [Usage Report] of [Print Statistics] is set to [Disable].

To print

- 1 Press the <Fn> key.
The numerical values input screen will be displayed.

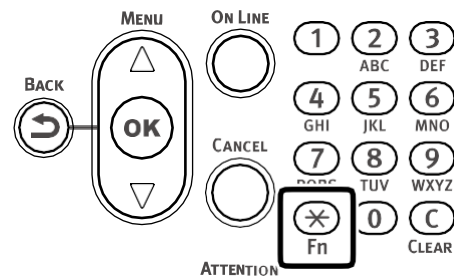

- 2 Press <1>, <0>, <2> (function numbers), and then press the <OK> button.

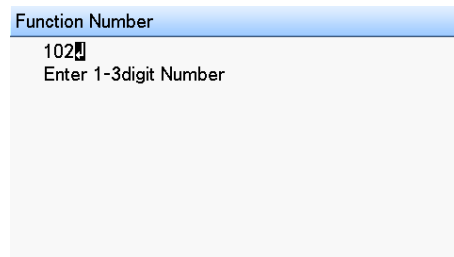

- 3 Confirm that [Execute] is selected, and then press the <OK> button.

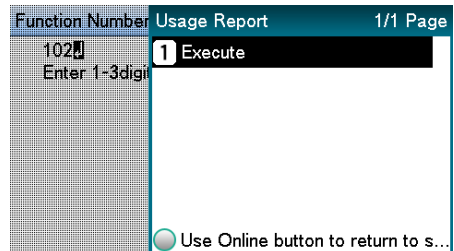

- Use the numeric keypad or the scroll buttons (▲, ▼) to specify the number of copies, and then press the <OK> button.

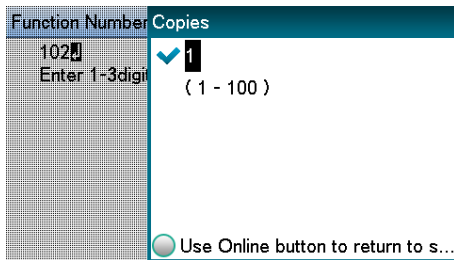

Printing Print Lists

Color Profile List

Prints the table of the ICC profiles registered on the printer.

■ To print

- Press the scroll button ▲ or ▼.

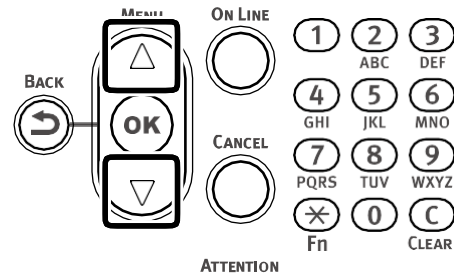

- Select [Print Information], and then press the <OK> button.

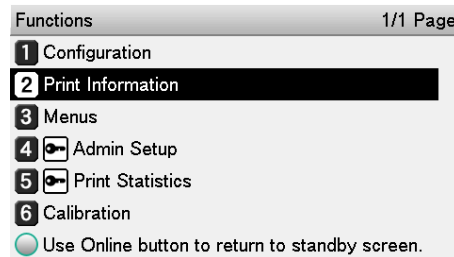

- Select [Color Profile List], and then press the <OK> button.

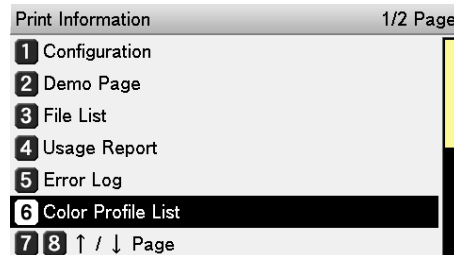

- Confirm that [Execute] is selected, and then press the <OK> button.

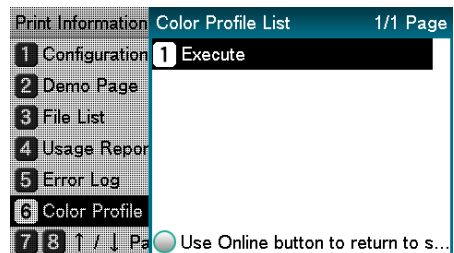

User Media List

Prints the table of the user media registered to the device.



- Displayed when the user media is registered.

To print

1 Press the scroll button ▲ or ▼.

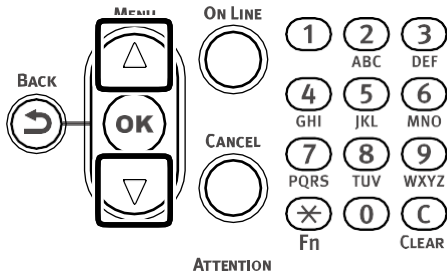

2 Select [Print Information], and then press the <OK> button.

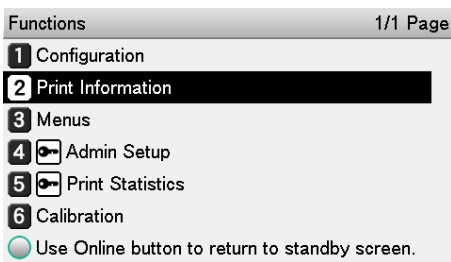

3 Select [User Media List], and then press the <OK> button.

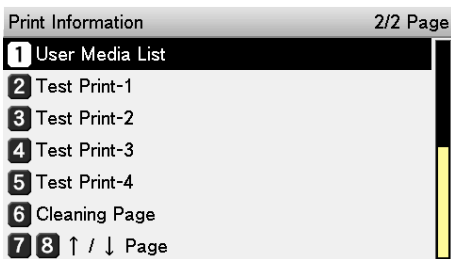

4 Confirm that [Execute] is selected, and then press the <OK> button.



Test Print

Prints the print quality lists.

- Test Print-1

Prints the patterns for analyzing the print quality.

- Test Print-2

Prints the patterns for analyzing CMYK print quality.

- Test Print-3

Prints the patterns for analyzing the status of the print cartridges.

- Test Print-4

Prints the patterns for analyzing print quality of the spot colors (white).

To print

1 Press the scroll button ▲ or ▼.

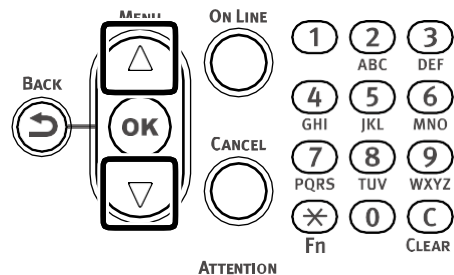

2 Select [Print Information], and then press the <OK> button.

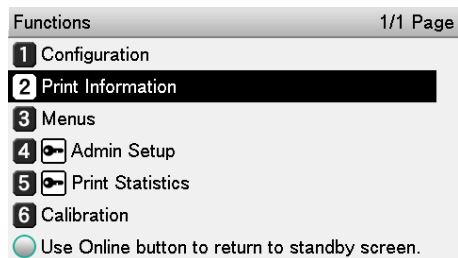

3 Select [Test Print-1], [Test Print-2], [Test Print-3], or [Test Print-4], and then press the <OK> button.

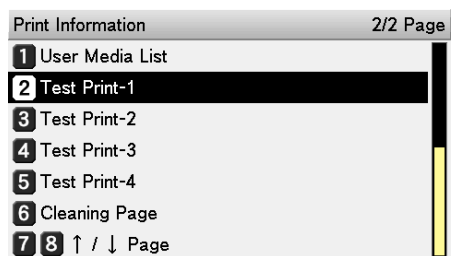

- When [Execute] appears, press the <OK> button.

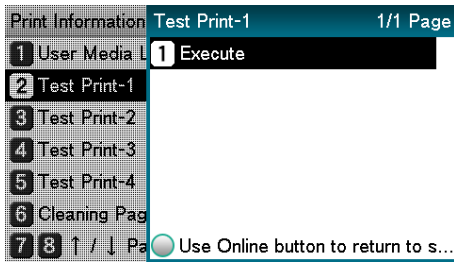

Changing the Administrator Password

Change the administrator password. The factory default setting is [999999].

- Press the scroll button ▲ or ▼.

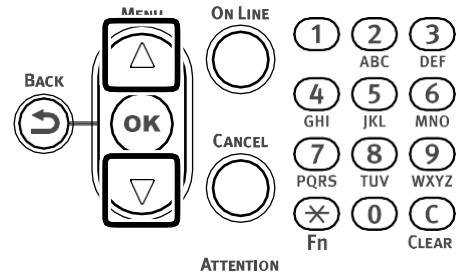

- Select [Admin Setup], and then press the <OK> button.

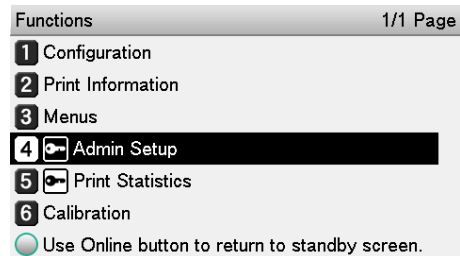

- Enter the administrator password, and then press the <OK> button.

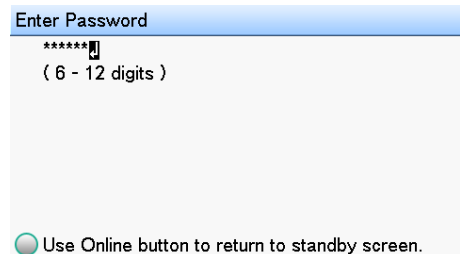

- Select [Change Password], and then press the <OK> button.

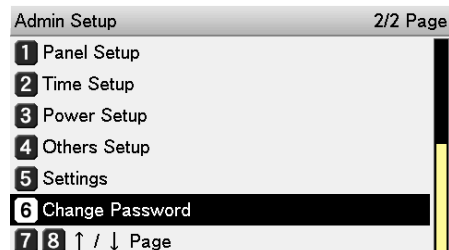

5 Enter the new password, and then press the <OK> button.



Note

- Specify a password that is at least six characters long.

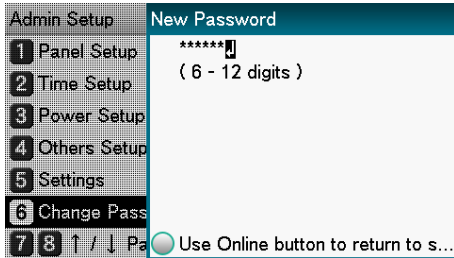

6 Re-enter the new password, and then press the <OK> button.

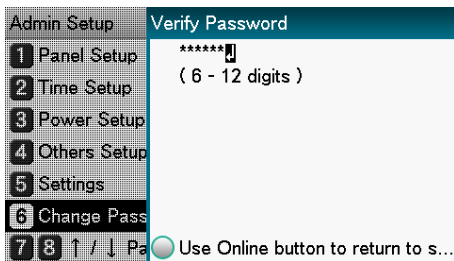

7 Press the <ON LINE> button to return to the standby screen.

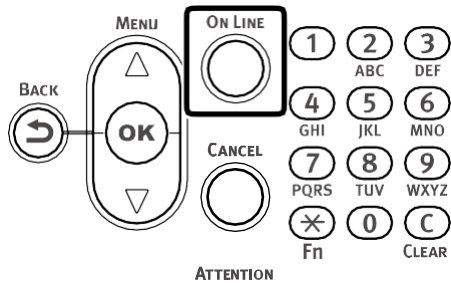

□ Checking the Print Count

You can check the quantity of paper printed from the unwinder to date.

1 Press the scroll button ▲ or ▼.

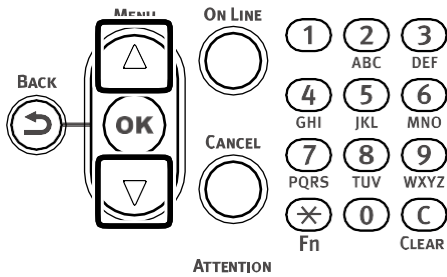

2 Select [Configuration], and then press the <OK> button.

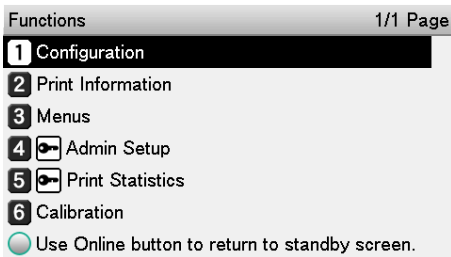

3 Select [Feeder Count], and then press the <OK> button.

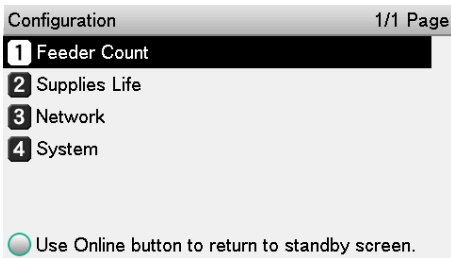

4 Select the feeder you want to check.

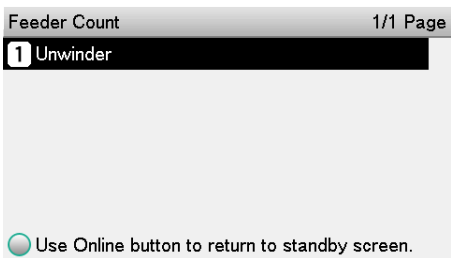

5 Press the <OK> button.

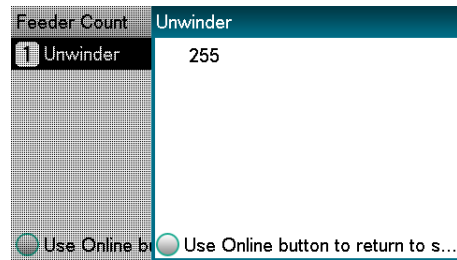

6 Press the <ON LINE> button to return to the standby screen.

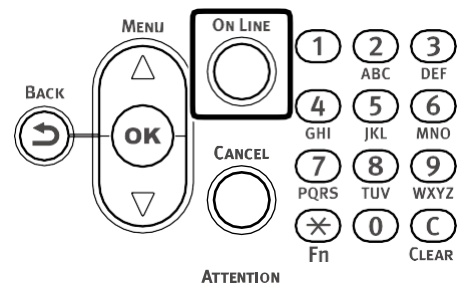



Utility Software Usable with This Printer

Utility List	140
Using a Web Browser to Configure the Network Setup	141
Network Extension.....	172

□ Utility List

Utility Name	Description	Operating Environment	Reference pages
Web Browser	Can be used to view messages displayed on the printer, and to configure network settings and other settings.	Computer with Microsoft Internet Explorer, Safari, Google Chrome, or Firefox installed	Page 153
Network Extension	Can be used to check printer setup items from a printer driver and to configure option settings. This utility is installed automatically when a printer driver is installed on a network connection.	Windows 10/Windows 8.1/ Windows 8/Windows 7/ Windows Server 2016/ Windows Server 2012 R2/ Windows Server 2012/ Windows Server 2008 R2/ Windows Server 2008/ Computer running TCP/IP	Page 190

□ Using a Web Browser to Configure the Network Setup

Operating Environment

Computer with Microsoft Internet Explorer, Safari, Google Chrome, or Firefox installed

Computer running TCP/IP



Memo

- Check to make sure that the security setting of the web browser is MEDIUM.

The explanation here is based on the example environment described below.

- Printer name: LT5C
- Printer IP address: 192.168.0.2
- MAC Address: 00:80:87:84:9C:9B
- Web Browser: Microsoft Internet Explorer Ver.11

Starting Up

- 1 Start up the web browser.
- 2 In the address bar, enter the following URL then press [Enter]: `http://<printer IP address>/`.



This displays the printer status screen.



Note

- If the IP address includes a one-digit or two-digit number, do not enter leading zeros. Doing so may cause communication problems.
Example: Correct: `http://192.168.0.2/`
Incorrect: `http://192.168.000.002/`

Logging in as an Administrator



Note

- To change printer settings using a web browser, you need to log in as a printer administrator.

1 Click [Administrator Login].

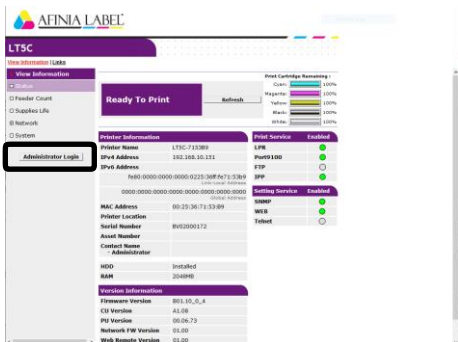

2 For [Username] enter "root", for [Password] enter the current password, and then click [OK].



Memo

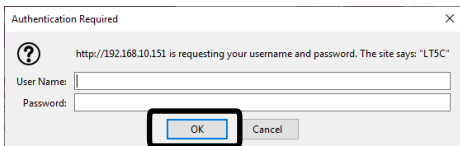

- The password is the same as the control panel "Administrator Password".

3 Specify the configuration information that can be checked on the network, and then click [OK] or [SKIP].

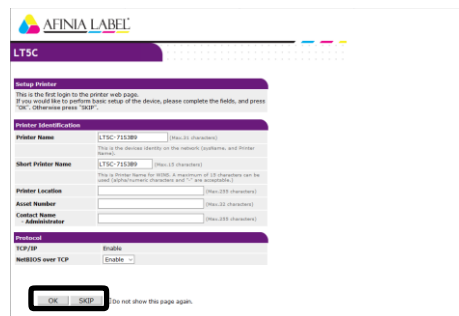

Note

- You can skip configuring settings by clicking [SKIP].
- Selecting the [Do not show this page again] checkbox, and then clicking [OK] or [SKIP] will cause this page not to be displayed any more.

4 This will display the screen below.



Item List

☉ : Appears for a person logged in as a printer administrator.

■ View Information



Item	Description
Status	Shows the current printer status. All warnings and errors generated by the printer are shown as "problem information". You can also check the operational status of each network service, a configuration list, and the IP address assigned to the printer. For information about the status window, see "To check using the "Status Screen"" (P.145).
Tray Count	Shows the print count.
Supplies Life	Shows the remaining life of consumables.
Usage Report	Shows usage reports.
Network	Can be used to check general information, TCP/IP status, maintenance information, and other network-related setup information.
System	Shows versions, memory capacity, flash memory capacity, and system related information.

■ Print Information ☉

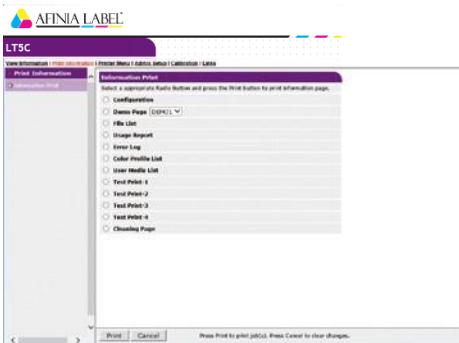

Item	Description
Information Print	Can be used to configure print and check information about the network, the font list, and other printer settings.

■ Printer Menu ☉

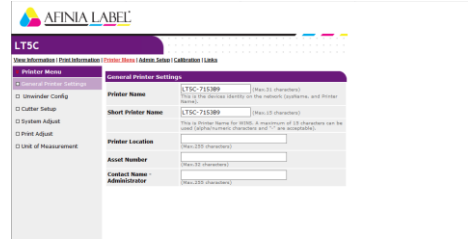

Item	Description
General Printer Settings	Can be used to configure the printer name, asset number, installation location, and other printer settings.
Unwinder Config	You can do settings related to the unwinder and the paper loaded in the unwinder.
Cutter Setup	You can set the cutter operations and the cutting interval. Appears when the unwinder is mounted.
System Adjust	Can be used to configure the power save time, and for clearing warnings, timeout printing, and other printer operations.
Print Adjust	Can be used to configure print position adjustment, print quality, and to adjust other settings.
Unit of Measurement	You can set the units that are displayed.

■ Admin Setup ☉



Item	Description
Network Setup	Can be used to configure TCP/IP and other protocol settings.
Print Setup	Can be used to configure toner saving and other printer settings.
PCL Setup	Can be used to configure PCL font and other PCL settings.
Color Setup	Can be used to configure PostScript settings for the CMYK data conversion process and other color settings.
Management	Can be used to configure the power setup, job cancel setup, and other printer settings.

■ Calibration



Item	Description
Normal Setting	Adjusts the density of each color and other print quality settings.
Customize Menu	Used to perform density and registration adjustment.

■ Links



Item	Description
Links	Displays links configured by the administrator and links configured by the manufacturer.
Edit Links	Allows administrator to set any URL. Up to five support links and five other links can be registered. Be sure to include http:// when entering the URL.

Changing an Administrator Password

You can use the procedure below to change the password for logging in to the printer as an administrator.

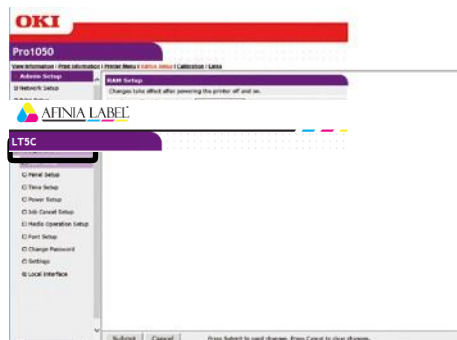

- 1 Click [Admin Setup] > [Management].
- 2 Click [Change Password] .

In [New Password], enter the new password. In [Verify Password], enter the new password again.

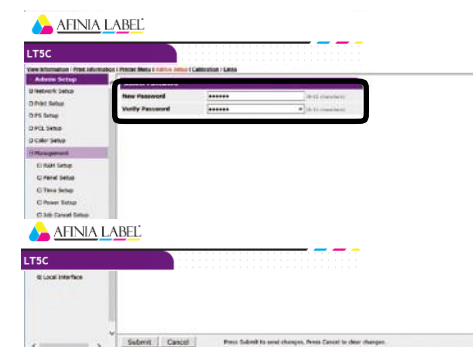

3

Note

- The password will appear on the screen as a series of dots (●●●●●●) as you enter it.
- You can enter from 6 to 12 alphanumeric English characters for a password.
- Note that passwords are case-sensitive, so enter upper-case and lower-case letters correctly.

- 4 Click [Submit].

- 5 This saves the settings on the printer. You do not need to re-start the printer. Use the new password the next time you log in as an administrator.

Checking Printer Settings From a Computer

You can use the procedures below to check the printer status from a computer over a network.

■ To check using the "Status Screen"

- 1 Access the printer web page and open the "Status" screen.

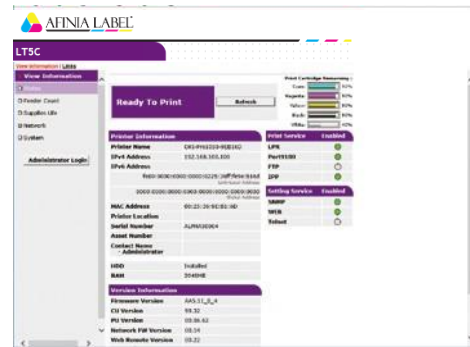

■ To check using the "Status Window"

Click [Status Window], which will display the screen shown below.



Shows printer information.

This displays details about the printer status.

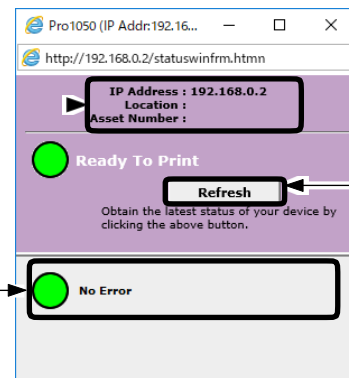

Click to update the printer status with the latest information.

Printer Status Icon	Meaning
	No error, online
	Minor malfunction (printing still possible)
	Serious malfunction (printing not possible)
	Offline

Changing Printer Settings From a Computer

You can use the procedure below to change printer settings.

- 1 Access the printer web page and log in as an administrator.

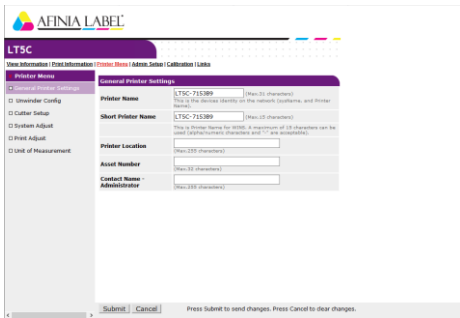

- 2 After changing the settings you want, click [Submit].

Encrypting Communication (SSL/TLS)

Communication between the computer (client) and printer can be encrypted when configuring settings, performing IPP printing, and when receiving print data with FTP protocol.

(Encryption of SSL/TLS Communication)

■ Configuring Settings

The procedure below shows how to use the web to create a certificate with the printer.

The two types of certificates below can be created.

- Self-signed certificate
- CA certificate (CSR creation)



- If the printer's IP address is changed from what it was when a certificate was created, that certificate become invalid. Do not change the printer's IP address after creating a certificate.

- 1 Log in as an administrator.



- See "Logging in as an Administrator" (P.142).

- 2 Click in the following sequence: [Admin Setup] > [Network Setup] > [Security].



- 3 Click [SSL/TLS].

4 Select the type of the certificate to create in [Step 1].



5 Enter information for the Common Name, Organization, and other items.



- If you selected "Use a certificate issued by a certificate authority", perform detailed content input and other certificate issuing procedures in accordance with issuing authority procedures.

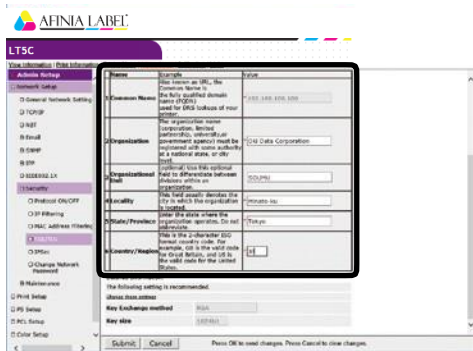

- If you selected a self-signed certificate, the printer's IP address will be set for [Common Name].

If you want to change the key exchange method and key size, click [Change these settings]. (The initial default setting is RSA, 1024 bits. Normally, you should use this setting without modifying it.)

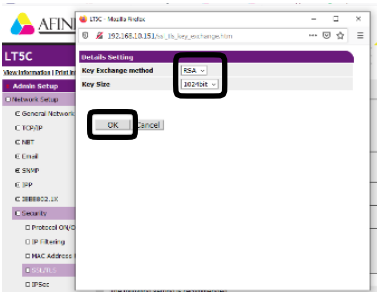

6 Click [OK].

Self-signed Certificate

To create a CA certificate, advance to "CA Certificate" (P.148).

7 This displays the input.

Check the contents, and then click [OK]. This creates the certificate.

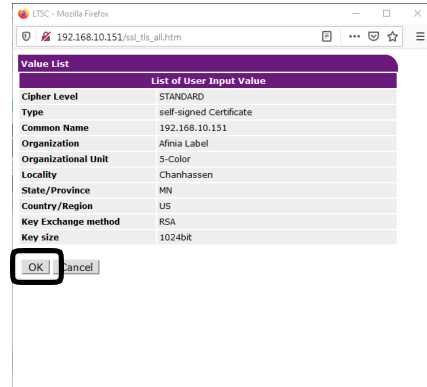

This completes self-signed certificate creation.

Settings are saved on the printer and the network function is restarted.

8 Perform steps 1 through 3 of this procedure to display the encryption (SSL/TLS) setup screen, and then configure protocol settings to enable encryption.

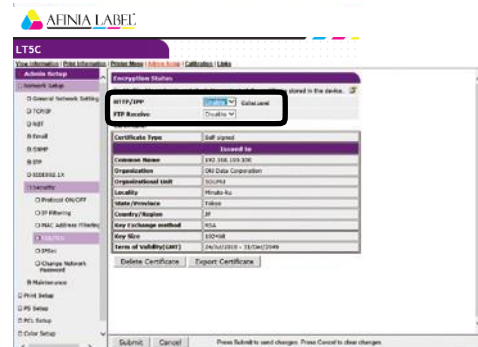

9 Click [Submit].

In this case, advance to "Usage Method" (P.148).

□ CA Certificate

7 This displays the input. Check the contents, and then click [OK].

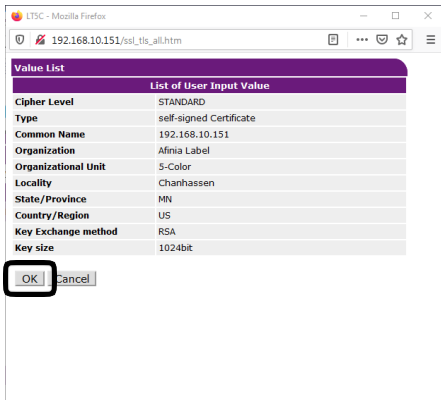

8 Extract the CSR and send it to the issuing authority. (For a CA certificate)



- Copy the contents of the text box from "-----BEGIN CERTIFICATE REQUEST -----" to "-----END CERTIFICATE REQUEST-----". Depending on the CA, sending the CSR may mean pasting it into web page, sending it as a file, attaching it to a mail message, etc.



9 This installs the certificate issued by the CA (using the web). (For a CA certificate)



Perform steps 1 through 3 of this procedure to display the encryption (SSL/TLS) setup screen.

Paste the part of the generated certificate from "-----BEGIN CERTIFICATE-----" to "-----END CERTIFICATE-----" into the text box, and then click [Send].

This completes CA certificate creation.

Settings are saved on the printer and the network function is restarted.

10 Perform steps 1 through 3 of this procedure to display the encryption (SSL/TLS) setup screen, and then configure protocol settings to enable encryption.

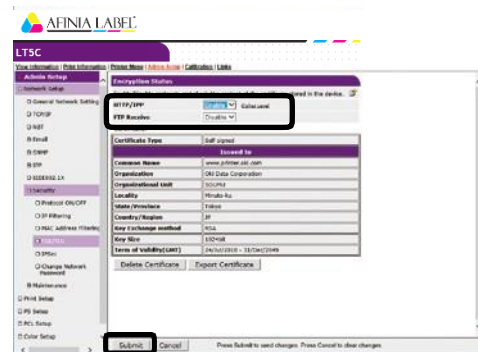

11 Click [Submit].

■ Usage Method

1 Start up the web browser, and then enter "https://<printer IP address>" as the address to connect.



Printing with IPP

Printing can be performed using IPP.

■ To enable IPP printing

- 1 Access the printer web page and log in as an administrator.
- 2 Select [Admin Setup].
- 3 Select the following: [Network Setup] > [IPP] > [Setting].
- 4 Follow the instructions that appear on the display to configure the setup.
- 5 Click [Submit].

■ To set up the printer as an IPP printer (Windows)

- 1 Click [Start] and select [Control Panel] in [Windows System].
- 2 Select [View devices and printers] > [Add a printer].
- 3 From the list of usable printers, select [The printer that I want isn't listed].

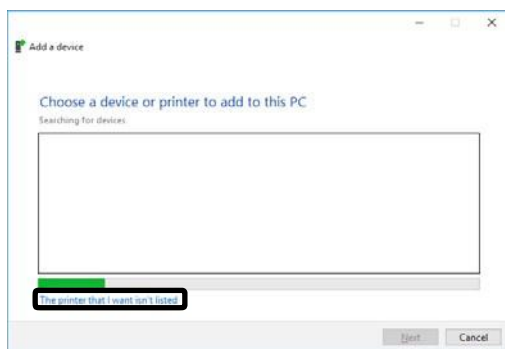

- 4 Select [Select a shared printer by name].

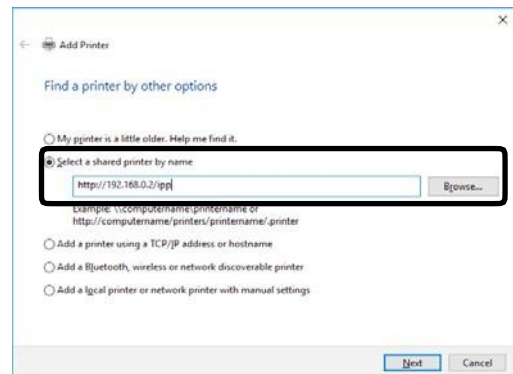

- 5 Enter "http://<printer IP address>/ipp" or "http://<printer IP address>/ipp/lp", and then click [Next].

- 6 Click [Have Disk].

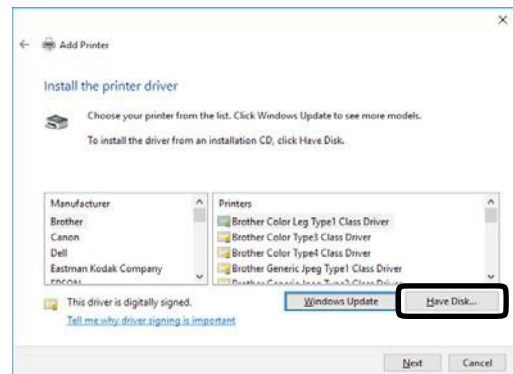

- 7 Insert the "Software DVD-ROM" into the computer.

- 8 For [Copy manufacturer's files from], enter one of the paths below, and then click [Find].

- PCL driver:
D:\Drivers\PCLXL

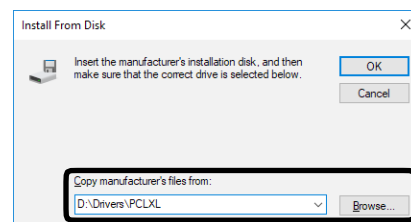

Memo

- The above is an example when the DVD-ROM drive is the D: drive.

- 9 Select the INF file, and then click [Open].

10 Click [OK].

11 Select the printer name, and then click [Next].

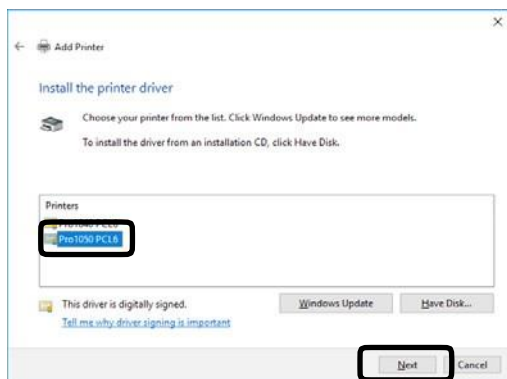

12 Click [Next].

13 Click [Finish].

14 A test page is printed after installation is complete.

Encrypting Communication (IPsec)

You can configure the settings in this section to encrypt and prevent tampering with communication between the computer (client) and printer at the network layer level.

Memo

- The IKE protocol supported by this printer is "IKEv1". The communication mode supported by this printer is "Transport Mode". It does not support "Tunnel Mode". Printer response may slow down while IPsec is enabled, depending on network communication conditions.

Note

- IPsec does not operate with the mail send function or SNMP Trap function.

■ Setup Flow

Configure printer settings before configuring computer settings.

■ To configure the printer setup

The procedure below shows how to use the web to enable IPsec.

1 Log in as an administrator.

Reference

- See "Logging in as an Administrator" (P.142).

2 Click in the following sequence: [Admin Setup] > [Network Setup] > [Security].

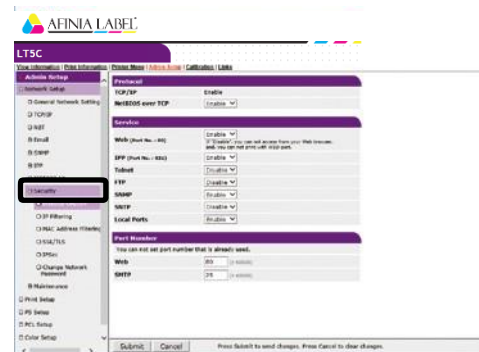

3 Click the [IPsec] tab.



4 Under [STEP1], enable [IPsec].



- Set "Enable" for IPsec to encrypt communications from the computer with the IP address you specified in "STEP2".
- The web page will not open if IPsec setup fails because the configured parameters do not match the computer, or because of some other reason. If this happens, use the control panel Network Setup item to disable [IPsec], or perform network initialization to disable IPsec.

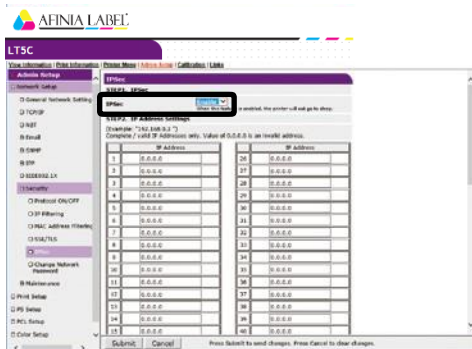

5 Under [STEP2], enter the host IP address.



- Use an IP address to specify a host that is allowed to print and configure settings.
- For the IPv4 address, use single-byte numerals separated by periods (.).
- For the IPv6 address, use single-byte alphanumeric characters separated by colons (:). Abbreviated notation is not supported.
- Entry of IP address 0.0.0.0. is invalid.

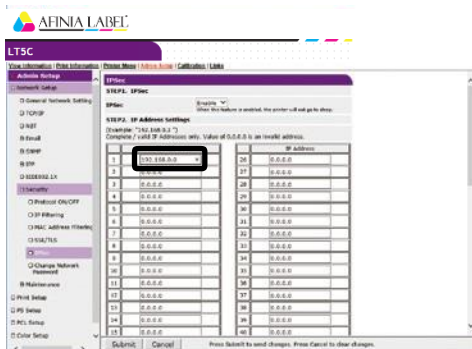

6 Using a Web Browser to Configure the Network Setup Under [STEP3], configure the settings of the Phase1 Proposal parameters.

- (1) For [IKE Encryption Algorithm], select one of the following settings: AES-CBC 256, AES-CBC 192, AES-CBC 128, 3DES-CBC, DES-CBC.
- (2) For [IKE Hash Algorithm], select SHA-1 or MD5.
- (3) For [Diffie-Hellman Group], select Group2 or Group1.
- (4) For [Lifetime], enter and set a value in the range of 600 (seconds) to 86,400 (seconds).

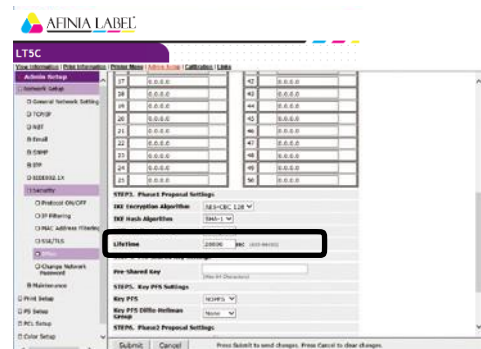

7 Under [STEP4], set the pre-shared key.

For [Pre-Shared Key], enter at least one and no more than 64 single-byte alphanumeric characters. Here, we will show an example where "ipsec" is entered for the character string.

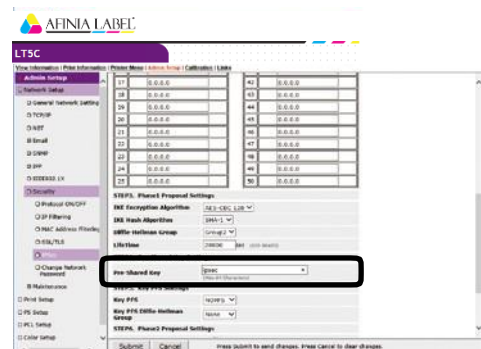

8 Under [STEP5], set the Key PFS.

- (1) For [Key PFS], select KEYPFS or NOPFS.

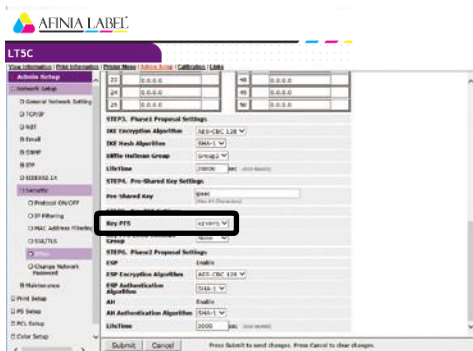

- (2) If [Key PFS] is selected, select one of the following settings for [Key PFS Diffie-Hellman Group]: Group 2, Group 1, None.

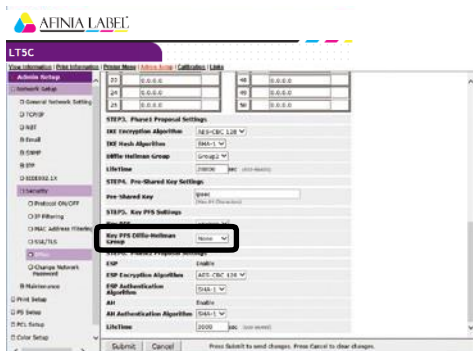

9 Under [STEP6], configure Phase2 Proposal settings.

- To configure [ESP] settings

- (1) For [ESP Encryption Algorithm], select one of the following settings: AES-CBC 256, AES-CBC 192, AES-CBC 128, 3DES-CBC, DES-CBC.
- (2) For [ESP Authentication Algorithm], select SHA-1, MD5, or OFF. If you select [OFF], the ESP verification algorithm will not be applied.

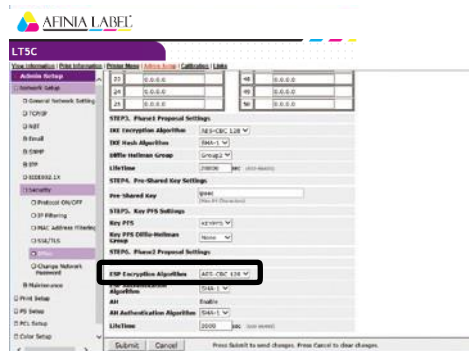

- To configure [AH] settings

- (1) For [AH Authentication Algorithm], select SHA-1 or MD5.

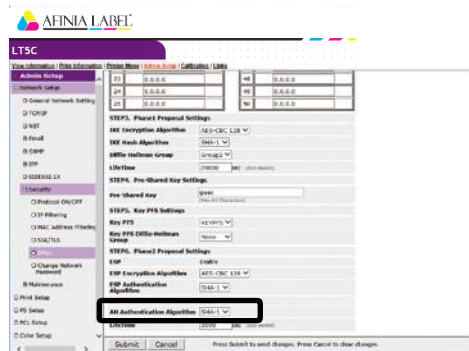

- (2) For [LifeTime], enter and set a value in the range of 600 (seconds) to 86,400 (seconds).

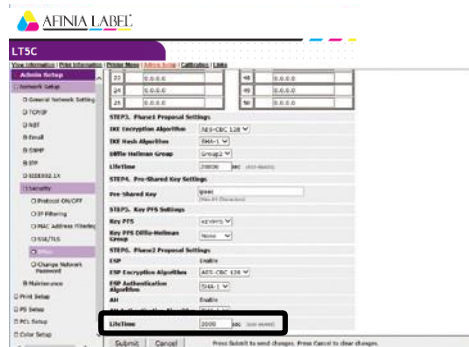

10 Click [Submit].

11 Settings are saved on the printer and the network function is restarted.

■ To configure computer settings

1 Click [Start], and then select [Control panel] in [Windows System].

2 Click [System and Security].

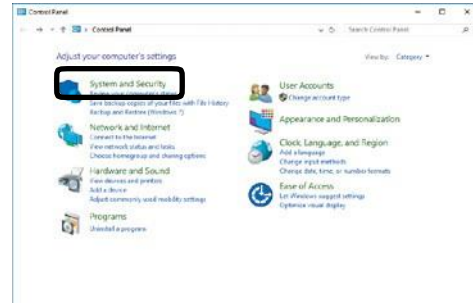

3 Click [Administrative Tools].

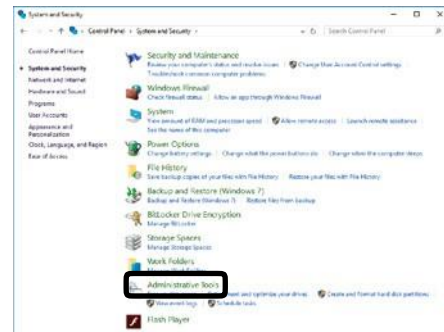

□ Connection Security Rules

4 Double-click [Local Security Policy].

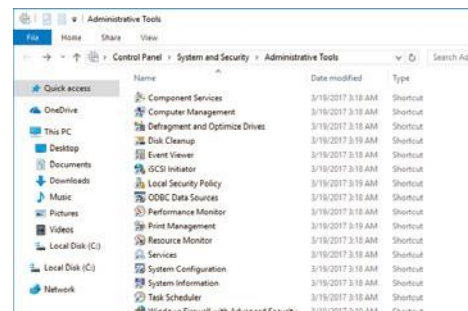

5 Select [Windows Firewall with Advanced Security] > [Windows Firewall with Advanced Security - Local Group Policy Object], right-click [Connection Security Rules], and then select [New Rule].

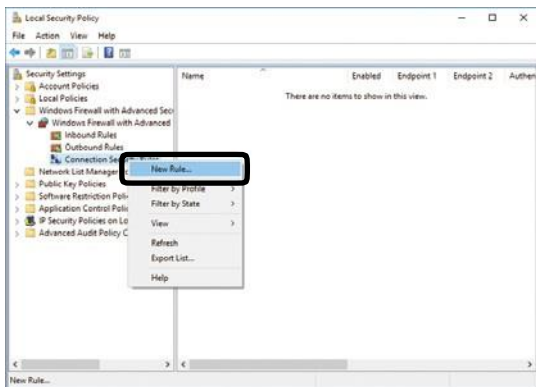

6 Select [Custom], and then click [Next].

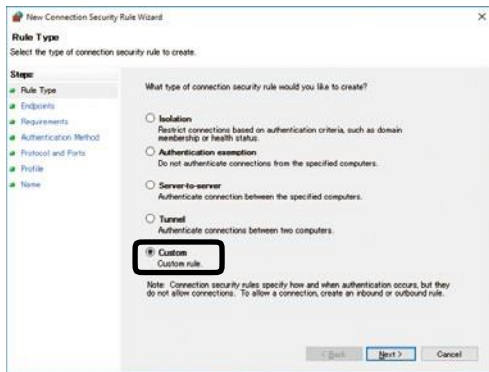

7 Select Endpoint 1 and 2. Configure as required, and then click [Next].

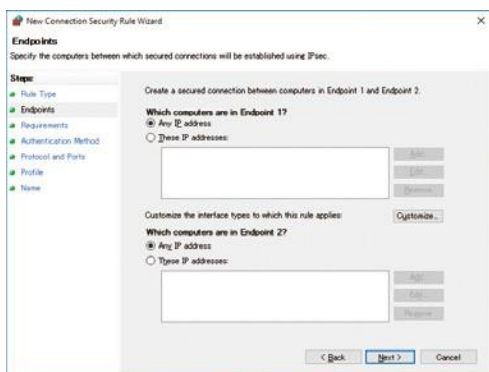

8 Select [Require authentication for inbound connections and request authentication for outbound connections], and then click [Next].

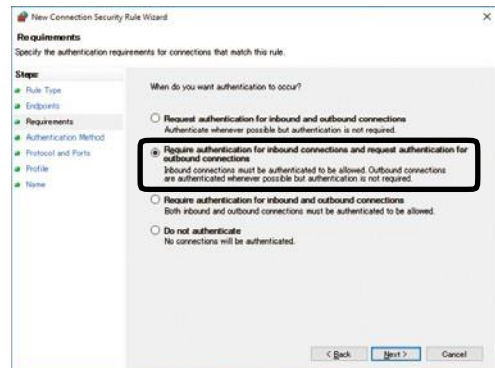

9 Select [Advanced], and then click [Customize].

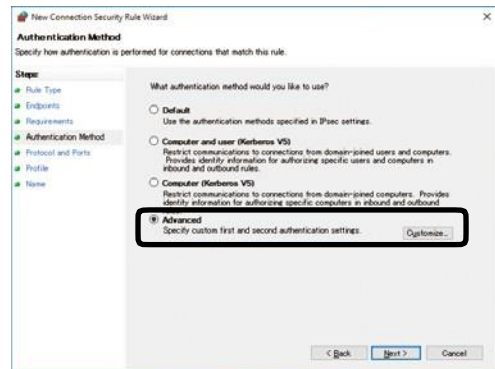

10 In the [First authentication] section, click [Add].

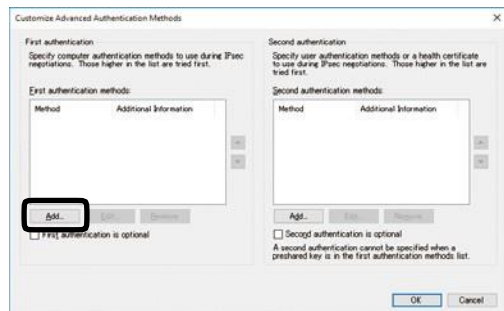

11 Select [Preshared Key] and enter the key, and then click [OK].

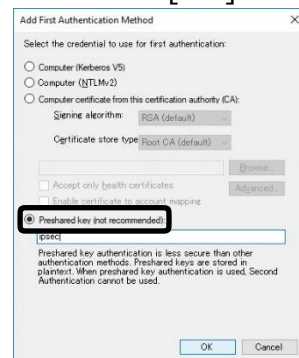

12 Click [OK].

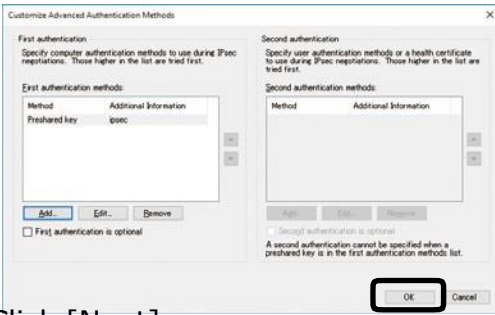

13 Click [Next].

14 Click [Next].

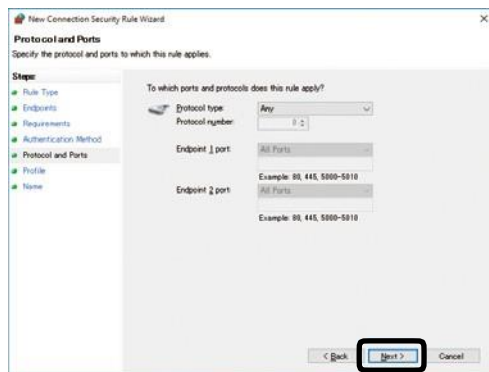

15 After confirming that all of the check boxes are selected, click [Next].

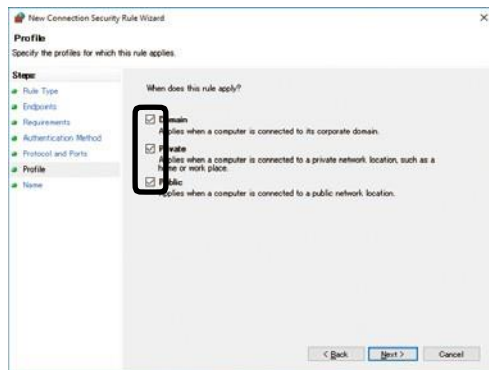

16 Enter a name, and then click [Finish].

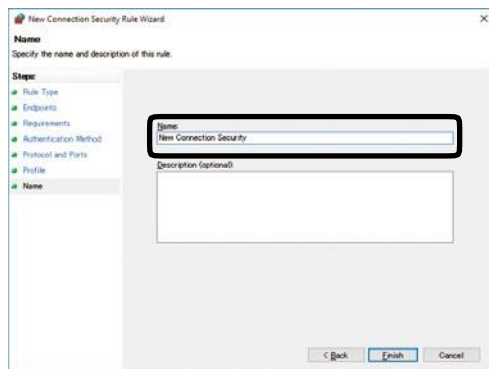

IPsec Setup

17 Open the [Local Security Policy] of the [Administrative Tools].

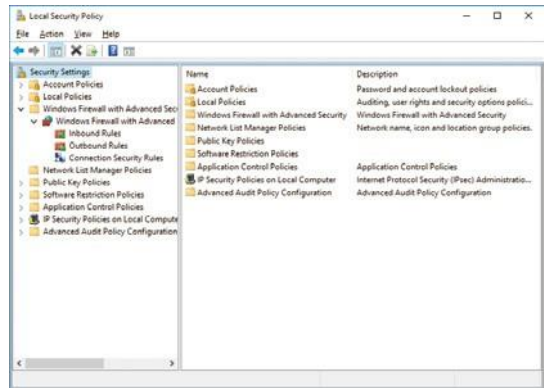

18 Right-click [Windows Firewall with Advanced Security], and then select [Properties].

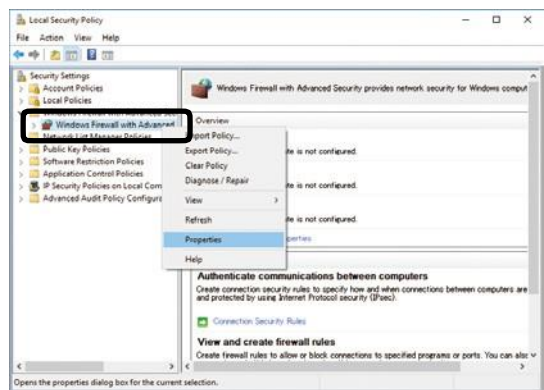

19 Select the [IPsec Settings] tab. Next, in the [IPsec defaults] section, click [Customize].

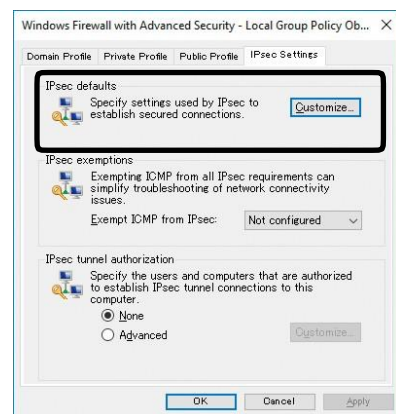

20 In the [Key exchange (Main Mode)] section, select [Advanced], and then click [Customize].

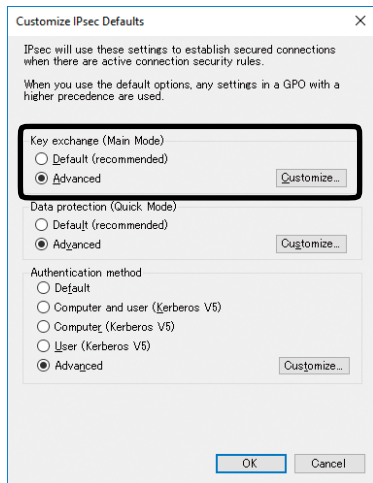

21 Change the [Security Methods] as required, and then click [OK].

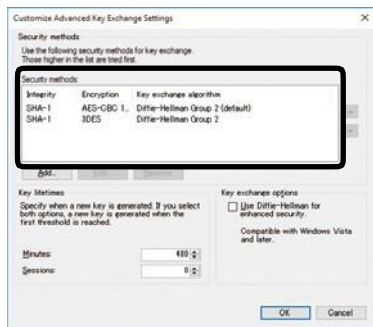

22 In the [Data protection (Quick Mode)] section, select [Advanced], and then click [Customize].

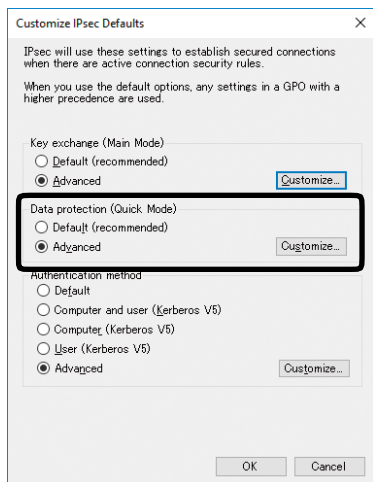

23 Configure the settings you want, and then click [OK].

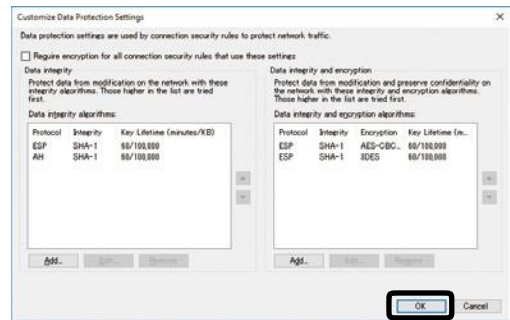

- Support is provided only for time indicated by the key lifetime. To disable session-specific (IPsec communication data size) conditions, set the maximum value.
- Select "ESP+AH" as the protocol.

24 In the [Authentication method] section, select [Advanced], and then click [Customize].

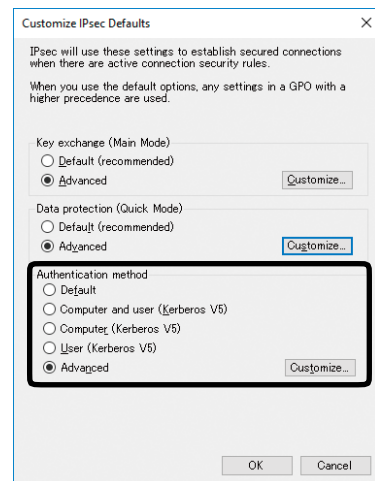

25 In the [First authentication] section, click [Add].

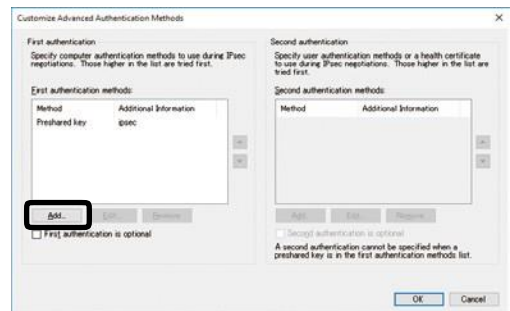

26 Select [Preshared Key] and enter the key, and then click [OK].



27 Click [OK].



28 Click [OK] to exit [Customize IPsec Settings].

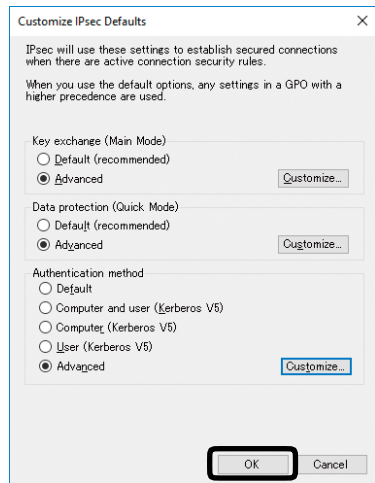

29 Click [OK].

Controlling Access by IP Address (IP Filter)

Access to the printer can be managed using IP addresses.



Note

- [IP Filtering] is set to [Disable] under the printer initial default settings.
- Take care to enter the IP address correctly. An incorrectly entered IP address can make it impossible to access the printer using IP protocol.

1 Log in as an administrator.



Reference

- See "Logging in as an Administrator" (P.142).

2 Click in the following sequence: [Admin Setup] > [Network Setup] > [Security].

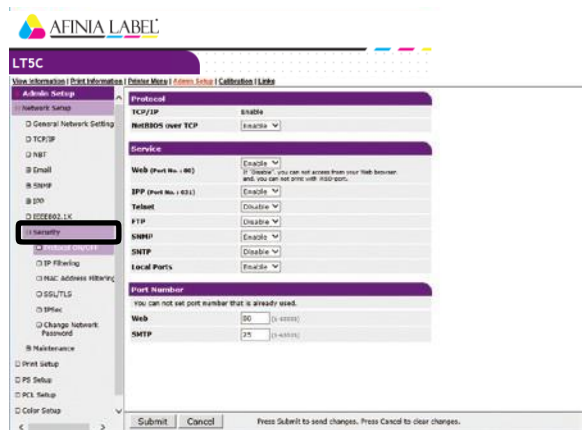

3 Click [IP Filtering].

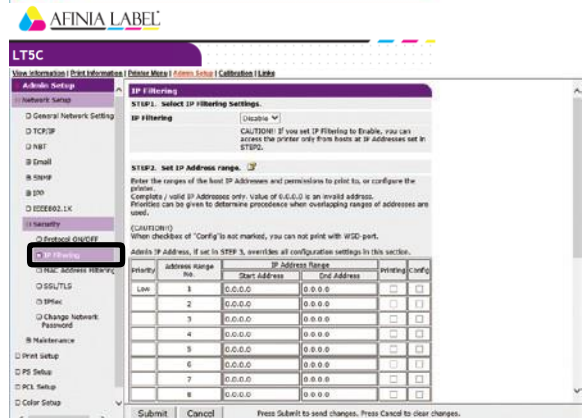

4 Under [STEP1], select [Enable] for [IP Filtering].

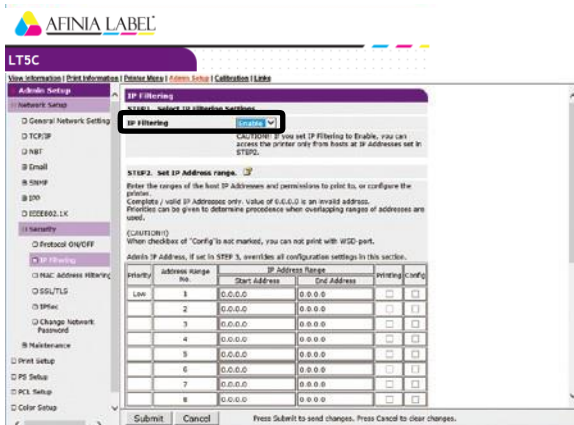

Note

- Enabling IP filtering disables all access from hosts that are outside the range of IP addresses specified in [STEP2].

5 Under [STEP2], specify the IP address range.



Note

- Using IP addresses, enter the range of hosts that are allowed to print and configure settings.
- For the IP addresses, use single-byte numerals separated by periods (.).
- Entry of IP address 0.0.0.0. is invalid.
- When there is overlap of IP addresses, the address range with the highest level set in [Priority] is given priority.
- Regardless of what is specified in [STEP2], you can use [STEP3] to specify administrator addresses for which printing and setting configuration are enabled.

6 Click [Address Range Bar Display/Refresh].

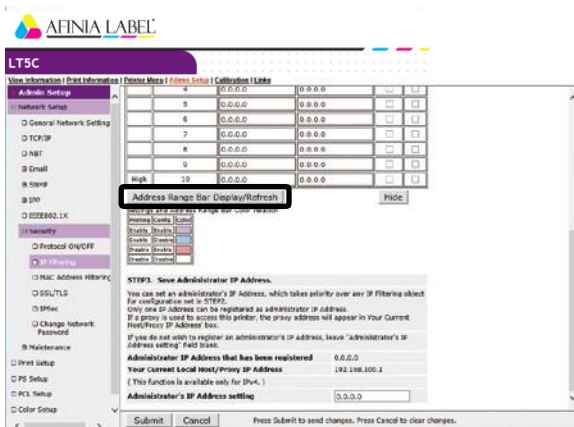

7 Under [STEP3], specify the [Administrator's IP Address setting].

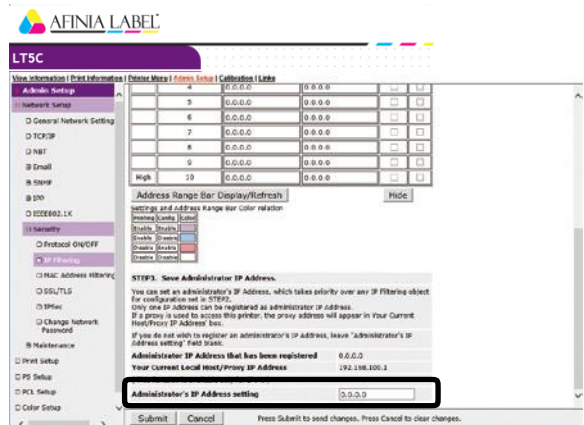

Even if the wrong settings are configured in [STEP2] due to administrator IP address entry in [Administrator's IP Address setting], the administrator can re-configure the setting from a host with the IP address specified with [Administrator's IP Address setting].



Note

- If the printer is being accessed via a proxy, the intermediate device's address will be displayed as [Your Current Local Host/Proxy IP Address]. Consequently, the address shown by [Your Host IP Address] may be different from your actual host address.
- If nothing is registered for the administrator IP address, the setting in [STEP2] may make the printer completely inaccessible.
- If you do not want to register an administrator IP address, leave [Administrator's IP Address setting] blank.

8 Click [Submit].

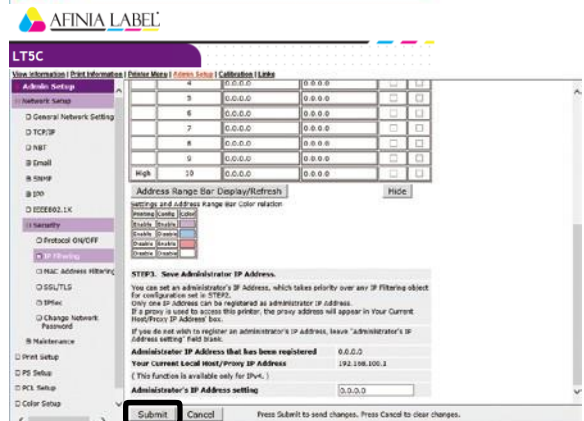

9 Settings are saved on the printer and the network function is restarted.

If you want to modify an IP address range, re-enter the applicable IP addresses, and click [Address Range Bar Display/Refresh].

Controlling Access by MAC Address

Access to the printer can be managed using MAC addresses.



- Incorrectly entering a MAC address can make it impossible to access the printer using a network. Exercise caution when entering an address.

1 Log in as an administrator.



- See "Logging in as an Administrator" (P.142).

2 Click in the following sequence: [Admin Setup] > [Network Setup] > [Security].



3 Click [MAC Address Filtering].

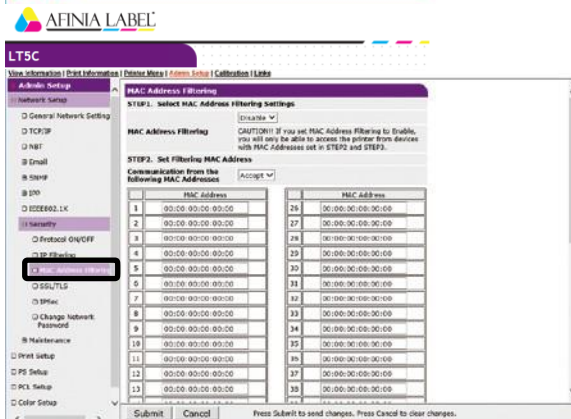

4 Under [STEP1], select [Enable] for [MAC Address Filtering].

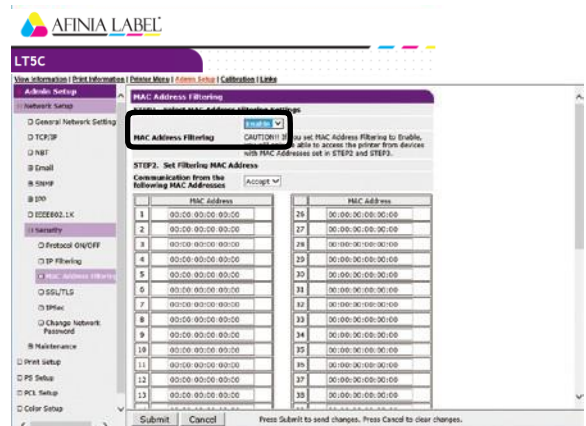

5 Under [STEP2], You can select [Accept] or [Deny] for communication from specific MAC addresses.

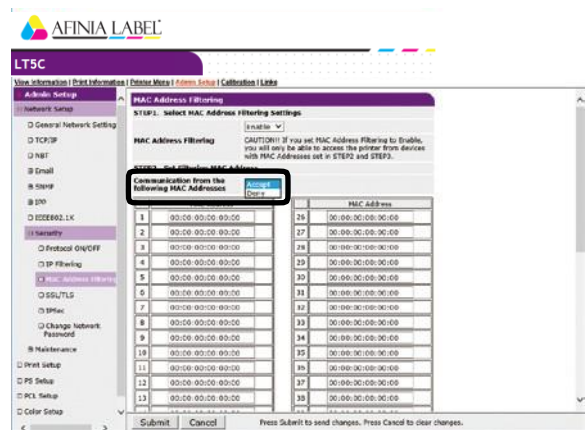

- Using MAC addresses, enter the range of hosts whose communications are allowed or rejected.
- For the MAC addresses, use single-byte numerals separated by periods (:).
- Regardless of what is specified in [STEP2], you can use [STEP3] to specify administrator addresses for which communication is enabled.

6 Under [STEP3], specify the [Administrator's MAC Address setting].

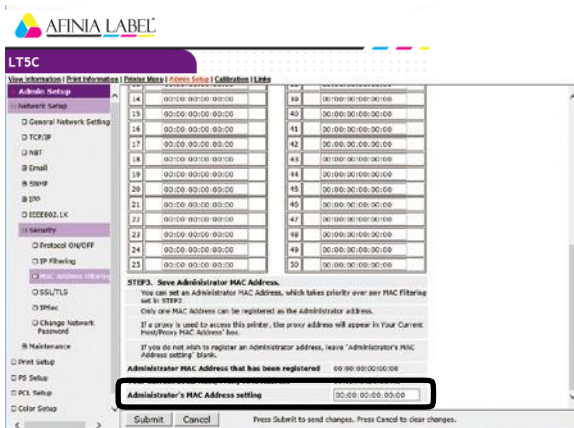

Even if the wrong settings are configured in [STEP2] due to administrator MAC address entry in [Administrator's MAC Address setting], the administrator can re-configure the setting from a host with the MAC address specified with [Administrator's MAC Address setting].



Note

- If the printer is being accessed via a proxy, the intermediate device's address will be displayed as [Your Host MAC Address]. Consequently, the address shown by [Your Host MAC Address] may be different from your actual host address.
- If nothing is registered for the administrator MAC address, the setting in [STEP2] may make the printer completely inaccessible.
- If you do not want to register an administrator MAC address, specify 00:00:00:00:00:00 for [Administrator's MAC Address setting].

7 Click [Submit].

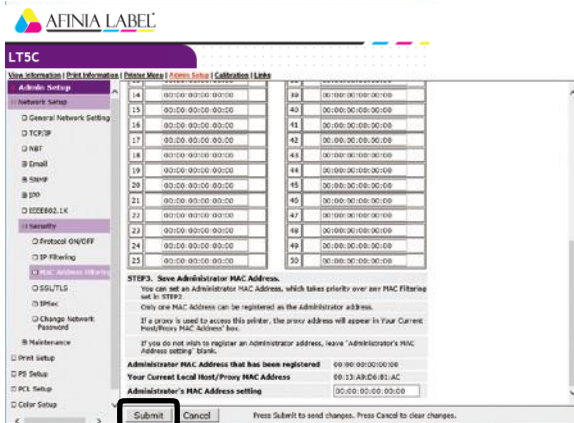

8 Settings are saved on the printer and the network function is restarted.

Sending Error Notifications by Mail

The printer comes with a mail sending function (SMTP) built-in. It can be configured to send a mail message whenever an error occurs. You can select whether to send a periodic mail message about errors, or to send a mail message as soon as an error occurs.

■ To configure settings for sending mail

1 Log in as an administrator.



Reference

- See "Logging in as an Administrator" (P.142).

2 Click: [Admin Setup] > [Network Setup].

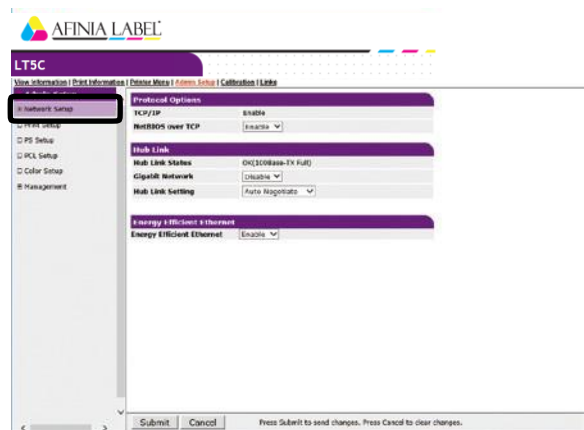

3 Click: [Email] > [Send Settings].

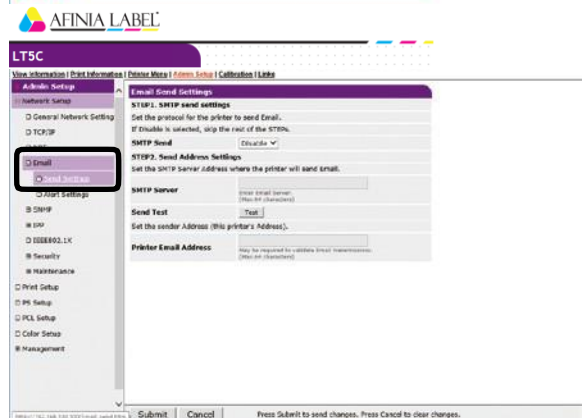

4 Under [STEP1], select [Enable] for [SMTP Send].

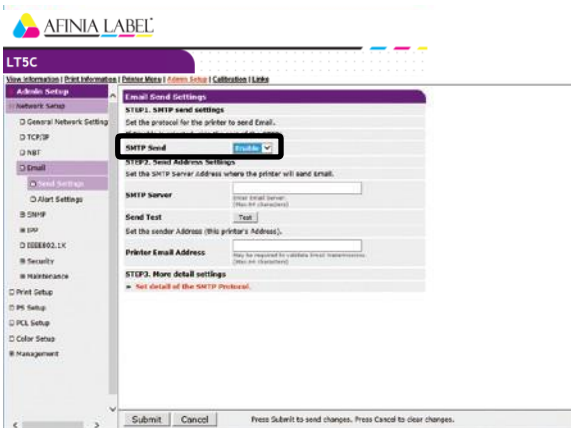

5 Under [STEP2], specify the required addresses.

- (1) For [SMTP Server], specify the mail server domain name or IP address.
- (2) For [Printer Email Address], specify the mail address assigned to the printer.

Note

- To configure SMTP server settings with a domain name, you need to configure DNS server settings with the [TCP/IP] setup.
- The mail server needs to be configured to allow the printer to send mail. For information about mail server settings, consult with your network administrator.
- Internet Explorer 7 configured with its initial default setup will not perform a send test. To perform a send test, you need to change the setup of Internet Explorer 7. Select [Tools] > [Security Level Customization], and then enable [Allow websites to prompt for information using scripted windows].

6 To configure more advanced settings from this point, click [Set detail of the SMTP Protocol.] for [STEP3].

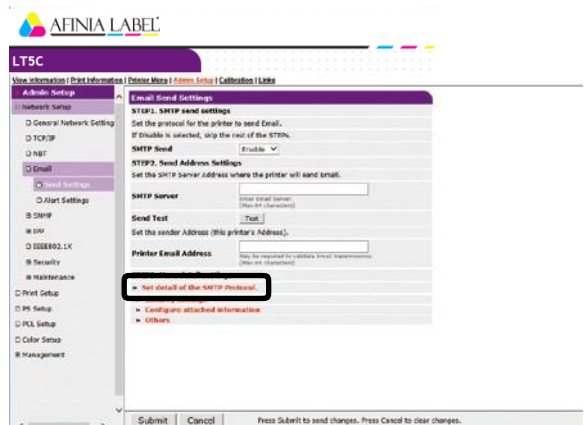

Otherwise, jump to step 16 of this procedure.

7 Click [Security Settings].

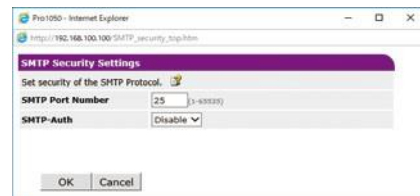

8 For [SMTP Port Number], specify the mail server port number.

9 Select [Enable] for [SMTP-Auth].

- (1) For [User ID], specify the user ID for connection to the mail server.
- (2) For [Password], specify the password for connection to the mail server.

10 Click [OK].

11 Click [Configure attached information].

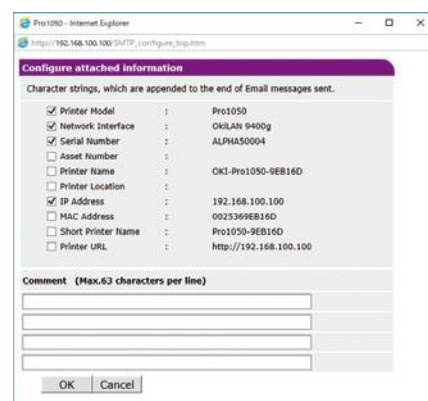

12 Select or enter the information you want to add to the end of the message text.

13 Click [OK].

14 Click [Others].

15 For [Reply-To Address], specify the return address for the mail sent from the printer. Normally, specify the mail address of the printer administrator.

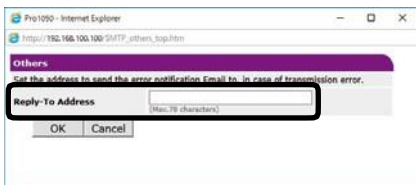

16 Click [OK].

17 Click [Submit].

18 Settings are saved on the printer and the network function is restarted.

Memo

- The authentication method is automatically selected from among authentication methods supported by the mail server.

Sending Error Notifications by Periodic Mail

■ To send periodic notifications about problems

For periodic notification, check that Auto Power Off setting is either Auto Config or Disable.

1 Log in as an administrator.



Reference

- See "Logging in as an Administrator" (P.142).

2 Click: [Admin Setup] > [Network Setup].

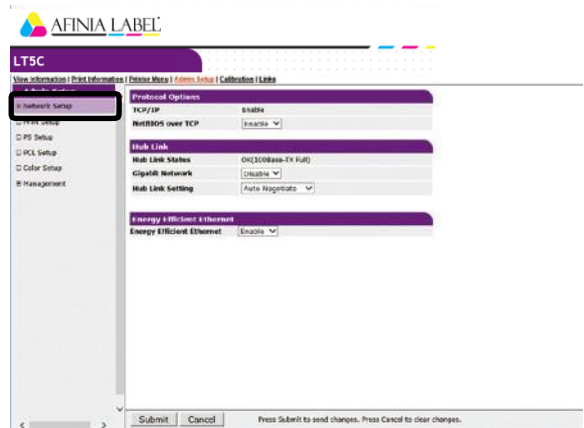

3 Click: [Email] > [Alert Settings].

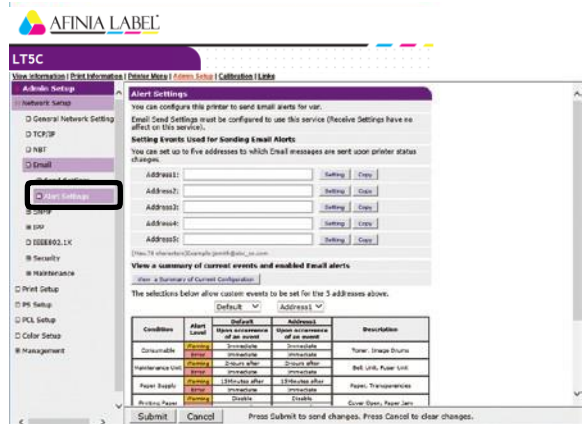

4 Enter the mail address of the malfunction notification recipient.

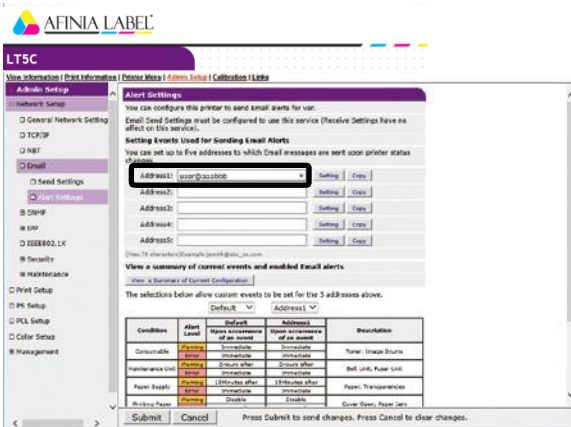

5 Click [Setting] of the mail address you want to specify.



- Malfunction notification condition settings can be copied to another addressee by clicking [Copy]. This is useful when sending malfunction notifications to multiple recipients with similar mail addresses.

6 Select the [Periodically] check box, and then click [To STEP2].

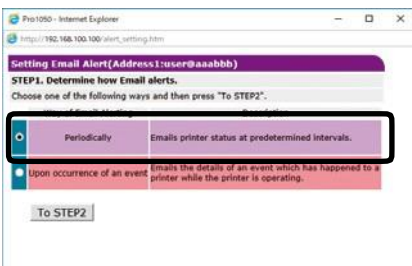

7 For [Email Alert Interval], specify the mail send interval.

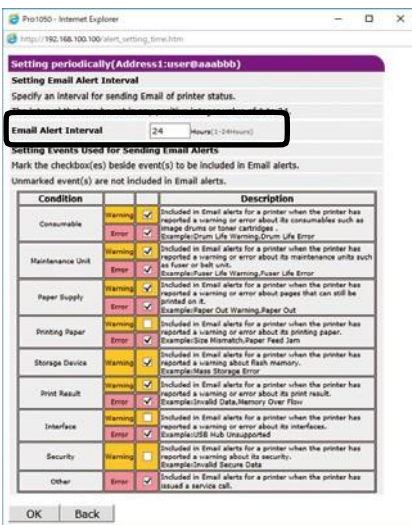

- Mail is not sent if there are no reportable errors within the period.

8 Under [Setting Events Used for Sending Email Alerts], select the check boxes of the error types for you to be notified of.

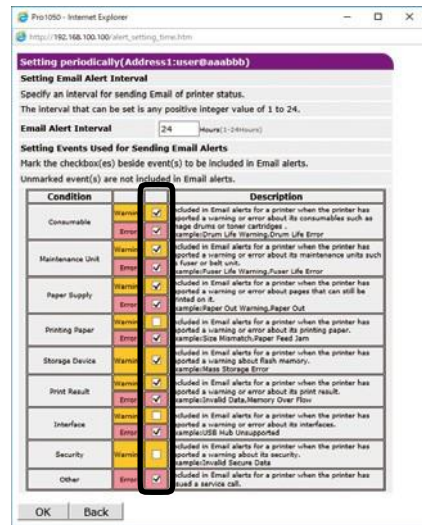

9 Click [OK].

10 Check the configuration of the malfunction notification conditions.

- To display as a list

(1) Click [Show current settings table].

(2) Check the configuration, and then close the window.

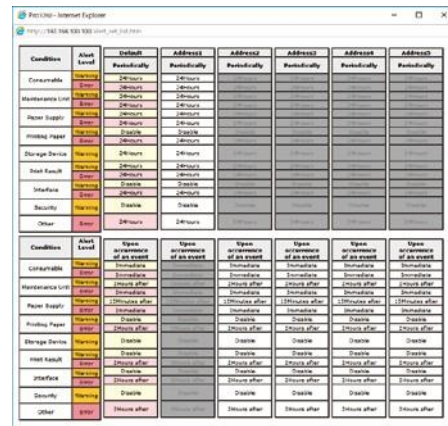

- To compare the setting conditions of two recipients

(1) Use the list box to select each of the recipients you want to compare.

(2) Check the displayed configuration.



- You can change notification condition settings by clicking inside the setting condition comparison table.

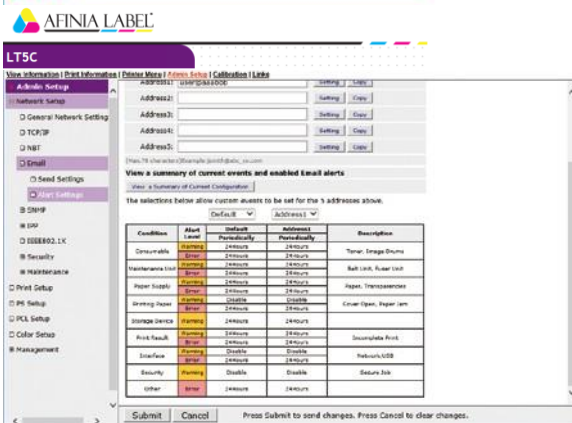

11 Click [Submit].

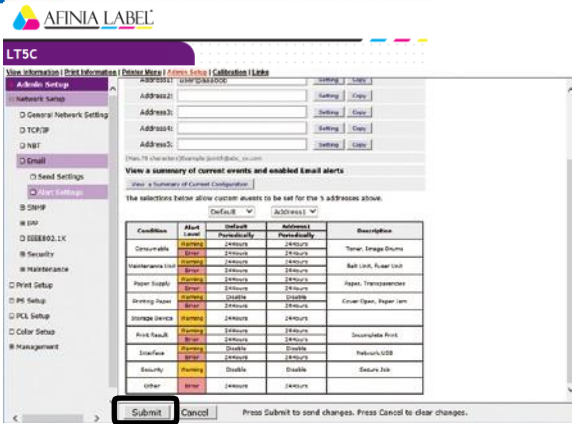

12 Settings are saved on the printer and the network function is restarted.

To send alerts when problems occur

1 Click: [Email] > [Alert Settings].

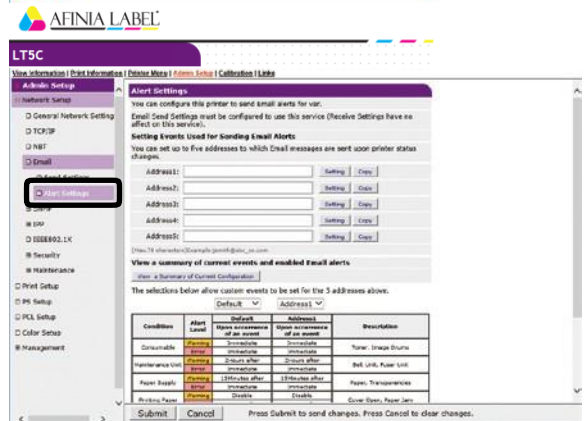

2 Enter the mail address of the malfunction notification recipient.

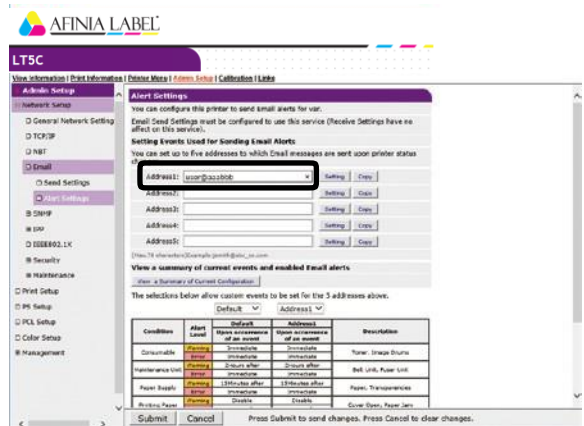

3 Click [Setting] of the mail address you want to specify.



- Malfunction notification condition settings can be copied to another addressee by clicking [Copy]. This is useful when sending malfunction notifications to multiple recipients with similar mail addresses.

4 Select the [Upon occurrence of an event] check box, and then click [To STEP2].



5 Under [Setting Events Used for Sending Email Alerts], select the check boxes of the error types for you to be notified of.

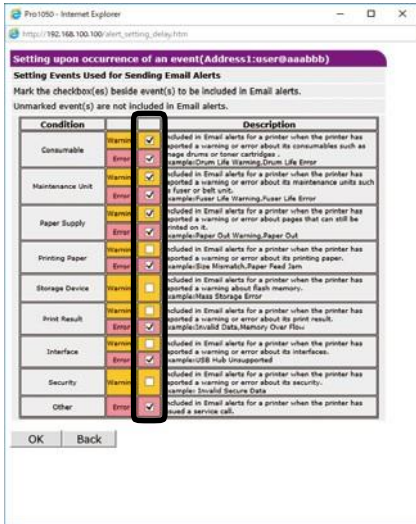

6 Specify the delay after an error occurs until the message is sent, and then click [OK].



Memo

- Setting a delay time makes it possible to send notifications only of errors that are generated only over a long period of time.
- Setting "0 hours, 0 minutes" for the delay time, causes the message to be sent immediately after an error occurs.

7 Click [OK].

8 Check the configuration of the malfunction notification conditions.

- To display as a list
 - (1) Click [Show current settings table].
 - (2) Check the configuration, and then close the window.

Condition	Alert Based	Default	Address1	Address2	Address3	Address4	Address5
Consumable	Event	Periodically	Periodically	Periodically	Periodically	Periodically	Periodically
Maintenance Unit	Event	24Hours	24Hours	24Hours	24Hours	24Hours	24Hours
Paper Supply	Event	24Hours	24Hours	24Hours	24Hours	24Hours	24Hours
Printing Paper	Warning	24Hours	24Hours	24Hours	24Hours	24Hours	24Hours
Storage Device	Warning	24Hours	24Hours	24Hours	24Hours	24Hours	24Hours
Print Result	Warning	24Hours	24Hours	24Hours	24Hours	24Hours	24Hours
Interface	Warning	24Hours	24Hours	24Hours	24Hours	24Hours	24Hours
Security	Warning	24Hours	24Hours	24Hours	24Hours	24Hours	24Hours
Other	Event	24Hours	24Hours	24Hours	24Hours	24Hours	24Hours

- To compare the setting conditions of two recipients
 - (1) Use the list box to select each of the recipients you want to compare.
 - (2) Check the displayed configuration.

Memo

- You can change notification condition settings by clicking inside the setting condition comparison table.

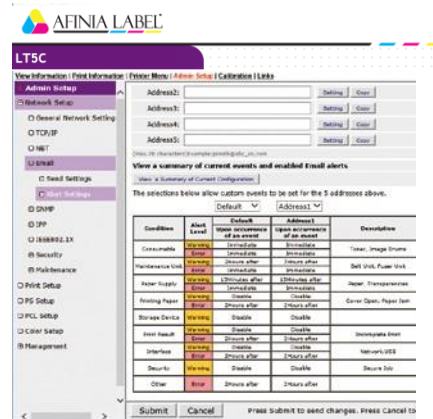

9 Click [Submit].

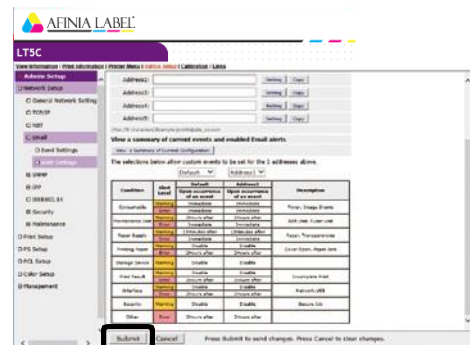

10 Settings are saved on the printer and the network function is restarted.

Using SNMPv3

This printer implements an SNMPv3 compatible agent.

You can use an SNMPv3 compatible SNMP manager to encrypt printer administration with SNMP for greater security.

1 Log in as an administrator.



- See "Logging in as an Administrator" (P.142).

2 On the [Admin Setup] tab, click [Network Setup].



3 Click [SNMP] > [Settings].

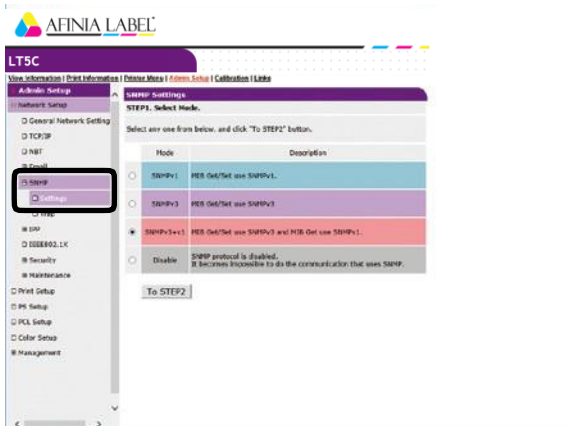

4 Select the check box of the SNMP version to be used in [STEP1], and then click [To STEP2].



- If [SNMPv3] is selected, you will not be able to view or configure settings with SNMPv1. If [SNMPv3+v1] is selected, you will be able to view settings with either SNMPv1 or SNMPv3, but you can configure settings using SNMPv3 only.

5 In [STEP2], enter an SNMPv3 user name for [User Name].

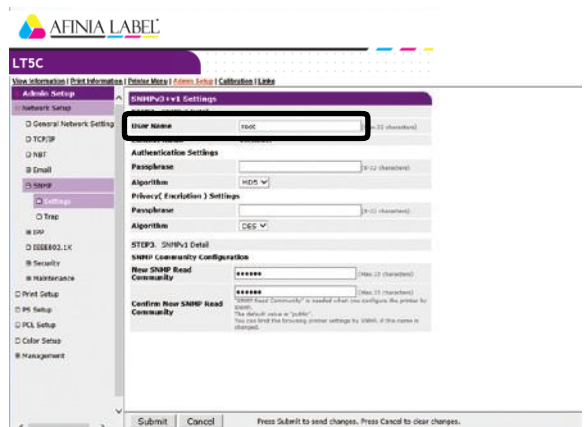

6 Enter the passphrase for verification in [Passphrase] for [Authentication Settings].

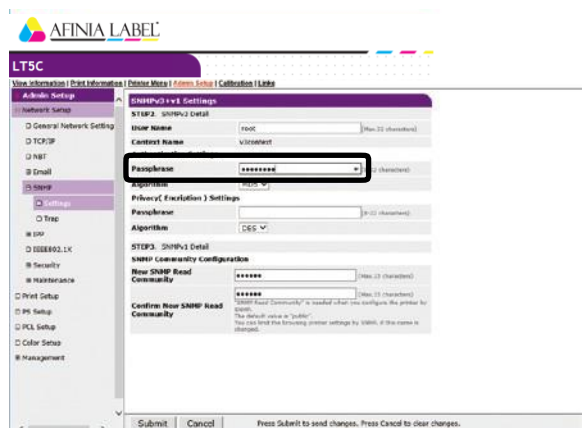

Using IEEE802.1X

Authentication is in accordance with IEEE802.1X.

■ IEEE802.1X Setup Flow

To configure IEEE802.1X settings on the printer, first connect the printer and computer via a normal hub for setup. After completing the IEEE802.1X setting configuration procedure, connect the printer to the authentication switch.

- 1 Connect the printer to a computer.
- 2 On the computer, specify an IP address for setting up.
- 3 On the printer, specify an IP address for setting up.
- 4 On the printer, configure IEEE802.1 settings.
- 5 Connect the printer to the authentication switch.

7 Select [Algorithm].

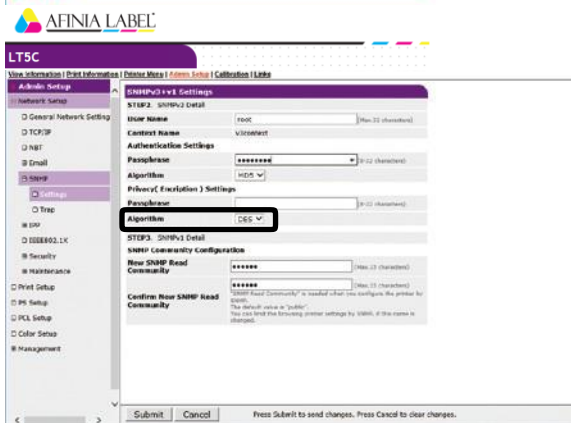

8 Enter the passphrase for encryption in [Passphrase] for [Privacy (Encryption) Settings].

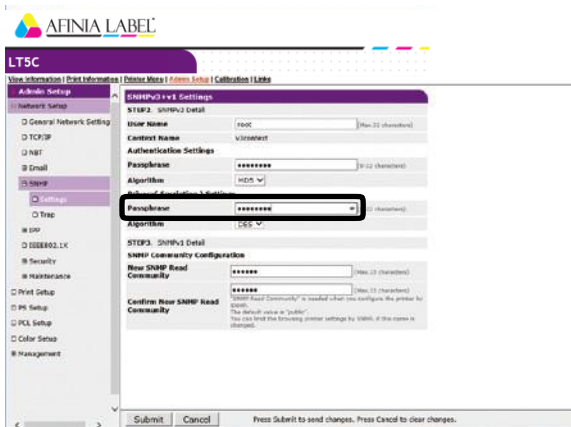

Memo

- You can select [DES] only for the encryption algorithm.

9 Click [Submit].

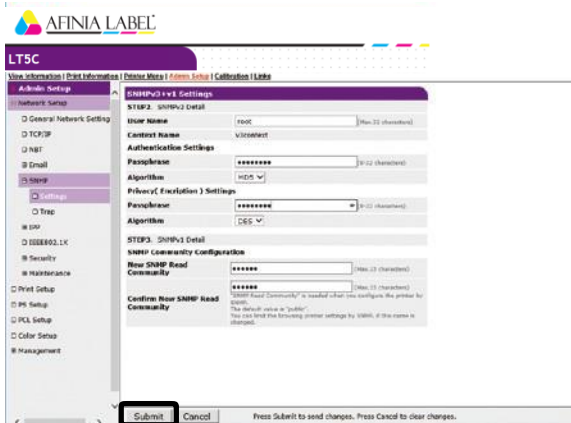

10 Settings are saved on the printer and the network function is restarted.



Memo

- For the context key of the SNMP manager to be used, specify "v3context".

■ To configure IEEE802.1 settings

1 Log in as an administrator.



- See "Logging in as an Administrator" (P.142).

2 On the [Admin Setup] tab, click [Network Setup].

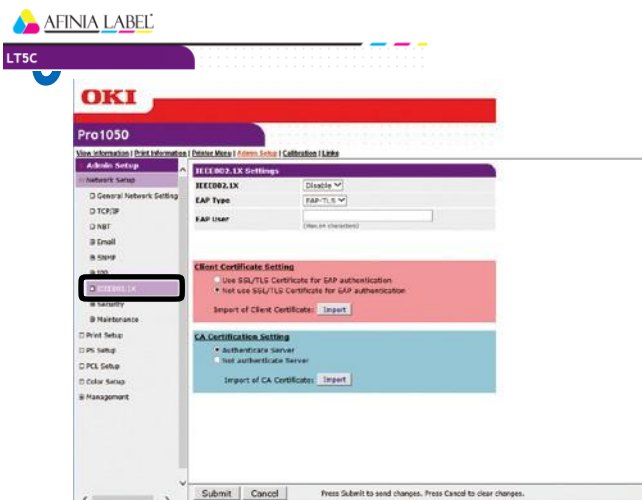
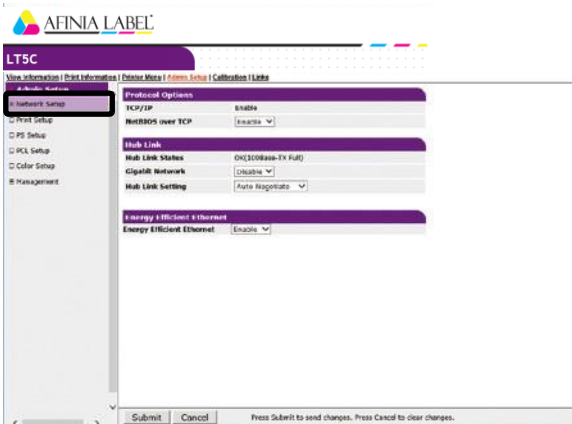

- If PEAP is to be used, proceed to "④ To use PEAP". If EAP-TLS is to be used, proceed to "④ To use EAP-TLS".

To use PEAP

4 For the [IEEE802.1X] setting, select [Enable].

5 For [EAP Type], select [PEAP].

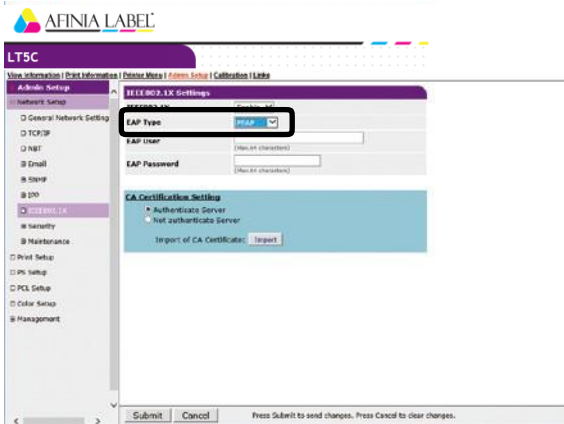

6 In [EAP User], enter the user name.

7 In [EAP Password], enter the password.

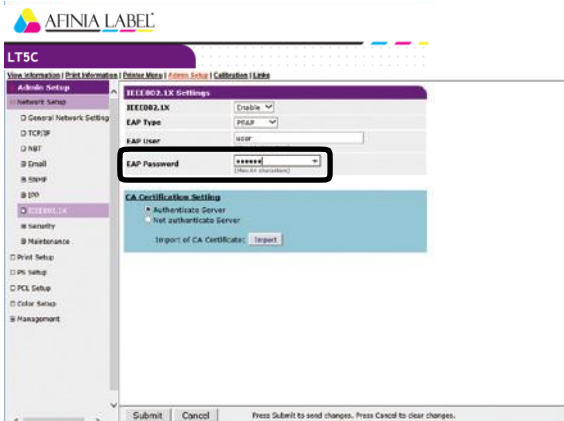

8 Select the [Authenticate Server] check box.

9 Click [Import of CA Certificate].



- If the [Not authenticate Server] check box is selected, import of a CA certificate is not required. If the [Not authenticate Server] check box is not selected, there is no confirmation to determine if the connection is to a properly authenticated server.

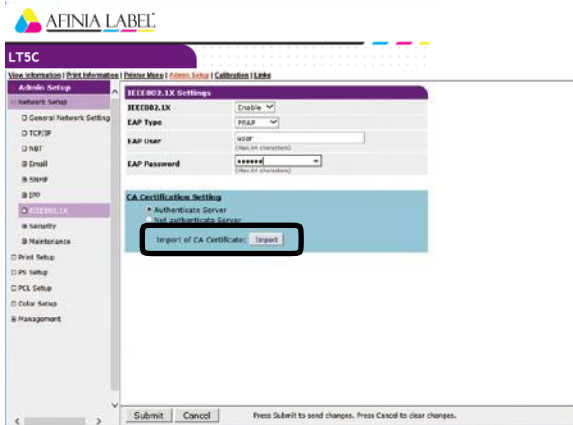

This displays the "Import of CA Certificate" screen.

10 Enter the file name of the CA certificate, and then click [OK].



- The imported CA certificate is a certificate of the server certificate issuing authority of the RADIUS server.
- Supported import file formats are PEM, DER, and PKCS#7.

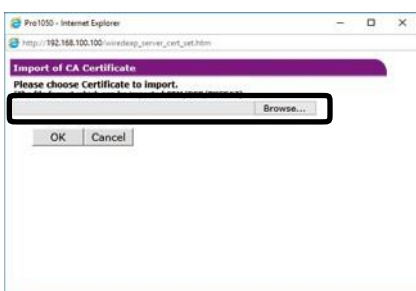

The CA certificate is imported by the printer.

11 Click [Submit].

12 Settings are saved on the printer and the network function is restarted.

When the standby screen appears on the control panel, turn off the printer.

4 For the [IEEE802.1X] setting, select [Enable].

5 For [EAP Type], select [EAP-TLS].

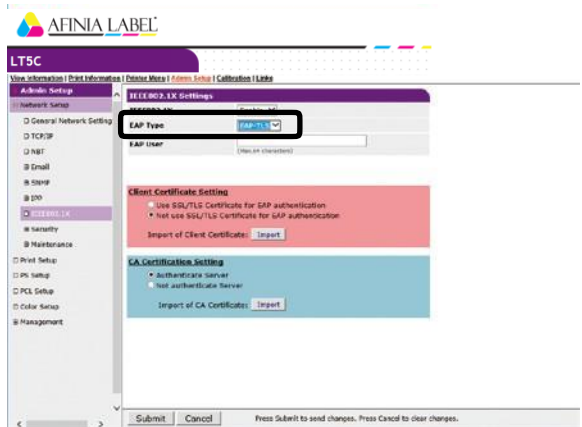

6 In [EAP User], enter the user name.

7 Select the [Not use SSL/TLS Certificate for EAP authentication] check box.

8 Click [Import of Client Certificate].

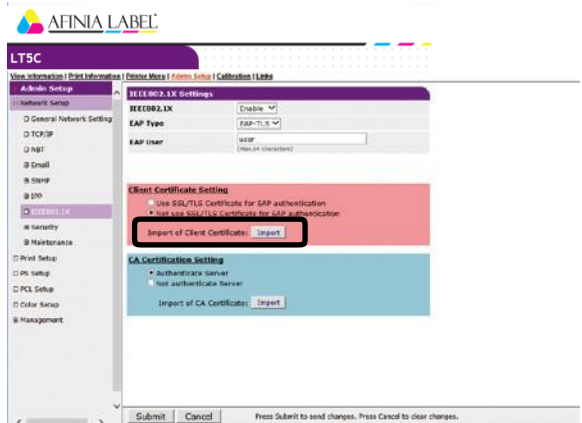

This displays the "Import of Client Certificate" screen.

9 Enter the file name of the client certificate.



- The importable certificate file format is PKCS#12.

10 Enter the client certificate password, and then click [OK].

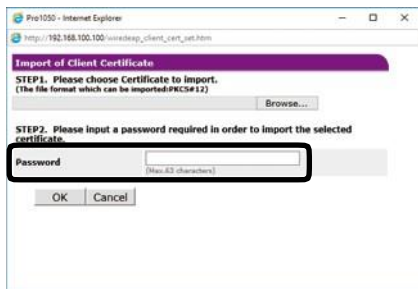

The client certificate is imported by the printer.

11 Select the [Authenticate Server] check box.

12 Click [Import of CA Certificate].



- If the [Not authenticate Server] check box is selected, import of a CA certificate is not required. If the [Authenticate Server] check box is selected, there is no confirmation to determine if the connection is to the correct authenticated server.

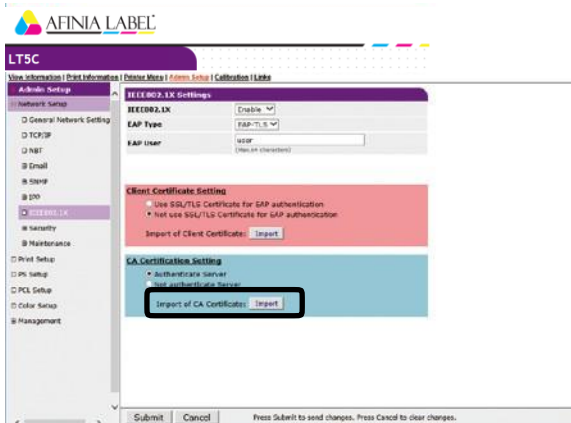

This displays the "Import of CA Certificate" screen.

13 Enter the file name of the CA certificate, and then click [OK].



- The imported CA certificate is a certificate of the server certificate issuing authority of the RADIUS server.
- Supported import file formats are PEM, DER, and PKCS#7.

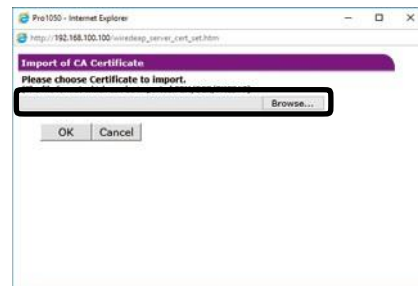

The CA certificate is imported by the printer.

14 Click [Submit].

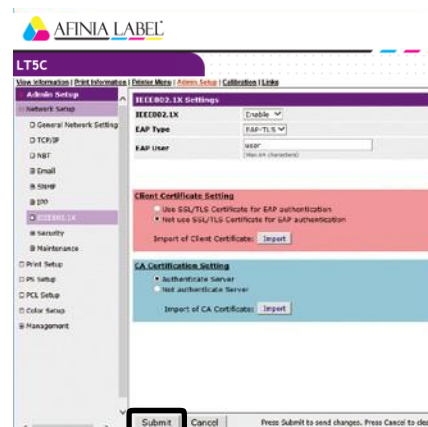

15 Settings are saved on the printer and the network function is restarted.

When the standby screen appears on the control panel, turn off the printer.



- For information about how to turn off the printer, refer to the "Setup Guide".
- Advance to "To connect the printer to an authentication switch" (P.171).

■ To connect the printer to an authentication switch



Memo

- Confirm that the printer is turned off.

- 1** Plug a LAN cable into the printer's LAN (network) interface connector.
- 2** Plug the LAN cable into the authentication switch's authentication port.
- 3** Turn on the power supply of the printer.
- 4** Confirm that the standby screen is displayed on the control panel.
- 5** Configure settings in accordance with the operating environment, such as the printer's IP address, etc.

Network Extension

Network Extension makes it easy to check printer setup items from a printer driver.

Reference

- Network Extension is installed along with the printer drivers.

Operating Environment

Computer running Windows 10/Windows 8.1/Windows 8/Windows 7/Windows Server 2016/Windows Server 2012 R2/Windows 2012/Windows Server 2008 R2/ Windows Server 2008

Computer running TCP/IP

Note

- To link operation with a printer driver, you need to install the printer driver.
- Network Extension is installed automatically when a printer driver is installed on a TCP/IP network connection.
- Operation is supported only for the printer driver connection destinations shown below.
 - Afinia Label LPR Port
 - Standard TCP/IP port
- PC administrator privileges are required for the setup.

Checking the Printer Settings

You can use the procedure below to check connected printer configuration, etc.

Note

- Even if Network Extension is installed, the [Options] tab will not be displayed if the operating environment is incompatible.

1 Click [Start] and select [Control Panel] in [Windows System].

2 Click [View devices and printers].

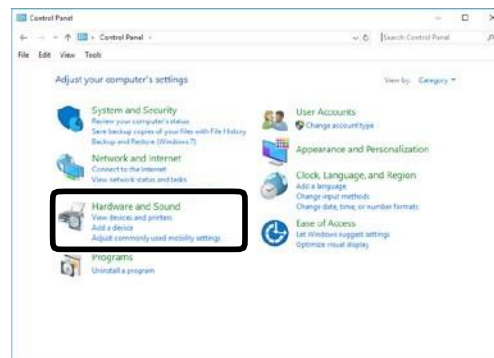

3 Right-click the [LT5C PCL6] icon, and then select [Printer Properties].

4 Click the [Status] tab.

5 Click [Update].

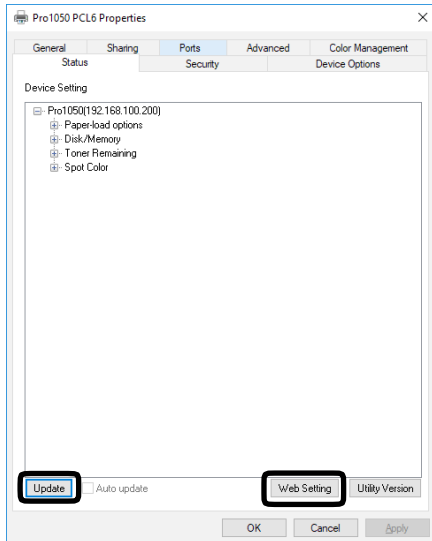

The printer configuration is displayed under "Device Setting".

6 Click [OK].

Memo

- Clicking [Web Setting] automatically starts up the web browser, which will display the printer configuration. For details, see ["Using a Web Browser to Configure the Network Setup" \(P.141\)](#).

Uninstalling Network Extension

- 1 Click [Start], and then select [Control panel] in [Windows System].
- 2 Click [Uninstall a program].
- 3 Select [Afinia Label Network Extension], and then click [Uninstall].
- 4 Follow the instructions on the screen to uninstall.

Index

A

Adjust Color Drift (Manual)	100
Adjust Density (Auto)	100
Adjust Density (Manual)	101
Adjusting Ultra Fine Lines	82
Administrator Password	136
Admin Setup	63, 143
Auto Density Mode	100

B

Black Finish	112
Black Finishing	112
Black Overprint	114

C

Calibrating the Sensor	30
Change Password	71
Check Unnecessary Print Cartridge	92
CMY100% Density	68
Collated Printing	88
Color Matching	
Automatic	109
Graphic Pro	111
No Color Matching	112
Simple Adjustment	110
Configuration	50
Cut Position	18

D

Dark	105, 107
Date	69
Density Fine Tuning	102
Device Setup Screen	50
DHCP Server	125

E

Encrypted Communication	146, 150
Encryption (SSL/TLS)	146

F

Fine Line Adjustment	82
----------------------------	----

H

Highlight	105, 107
Highly Detailed Printing	81

I

ICC Profile	110, 134
IEEE802.1X	167
Initializing Flash Memory	70
IP Address	164
IP Filtering	157
IPP	149
IPSec	63, 150

M

MAC Address Filtering	159
Mail Notification	160, 162
Manuals	
Marks and Symbols	3
Mid-Tone	105, 107
Mirror print	89

N

NetBIOS over TCP	63
Network Extension	172

O

Overlaying Stamps for Printing.....	87
Overlay Printing	90

P

Page Order	87
Paper	
Loading	24
Storage	14
Supported Paper	12
Password.....	144
Photo Enhance	81
Preventing Blurry Lines	82
Print Count	138
Printer Drivers	
Changing the Default Printer Driver	
Settings	96
Deleting a Printer Driver	97
Saving a Setup.....	93
Updating a Printer Driver.....	98
Using a Saved Setup.....	94
Windows PCL Printer Driver	48
Printing Composite Black.....	112
Printing Fine Lines Clearly.....	82
Printing Monochrome Shades	113
Printing Photographs Clearly	81
Printing Reports and Lists	
Color Profile List	134
Configuration	131
Demo Page	132
Error Log	133
File List	130
Test Print.....	135
Usage Report	133
User Media List.....	135
Printing the Color Tuning Pattern	104, 106
Printing True Black.....	112
Print Position	16, 84

R

Registered Form Printing	90
Returning the Network Setup to Its Factory	
Default.....	124

S

Setting Resolution	81
SNMP	63
SNMPv3.....	166
Sorted Printing	88
Specifying the Toner Save Amount.....	79
Spot Color	118
SSL/TLS	146
Suppressing White Streaking	114

T

TCP/IP	63
Time Setup	69
Time Zone	69
Toner Save	79
Toner Save Mode	79
Trapping.....	114
TrueType Fonts	82, 83

U

Usage Report	133
Use in a BOOTP Environment	126
Using Fonts	
Computer	83
Printer.....	82

V

View Information	143
------------------------	-----

W

Watermarks.....	87
Web Browser	141
Item List	143
Login	142
White Toner	119, 120
Writing Print Data to a File.....	92

Afinia Label

8150 Mallory Court
Chanhassen, MN 55317

<https://www.afinialabel.com>

February 2019
47232202EE Rev2