

USER MANUAL

# Matrix Remover & Slitter

THIS PRODUCT IS CERTIFIED:





## IMPORTANT NOTICE

**THE MACHINE CAN ALSO BE USED AS SLITTER ONLY.**

**WHEN YOU DO THAT, PLEASE REMOVE THE TOP MOTORIZED CORE HOLDER AND ADJUST THE CLUTCH KNOB ON THE UNWINDER CORE HOLDER.**

## CORE HOLDER



**Motorized core holder**



**Non-Motorized core holder**

*Use only on  
unwinder station*

Waste Matrix  
Take up mandrel / Weeder  
(Motorized)

Unwinder  
Supply mandrel  
(Non-Motorized)

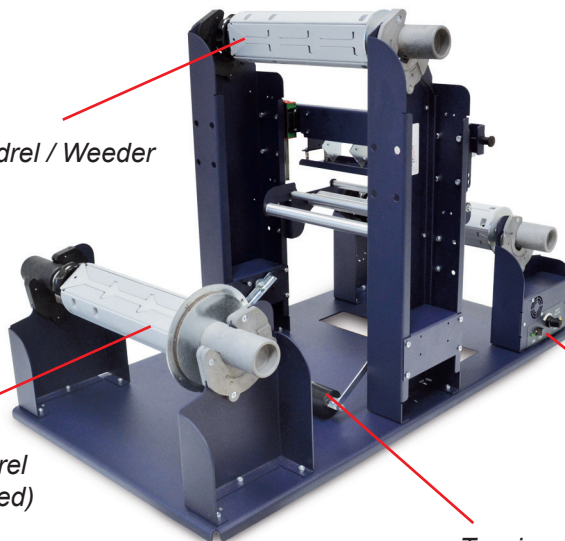

Slitter station

Take up mandrel  
(Motorized)

Slitter  
Blade Housing

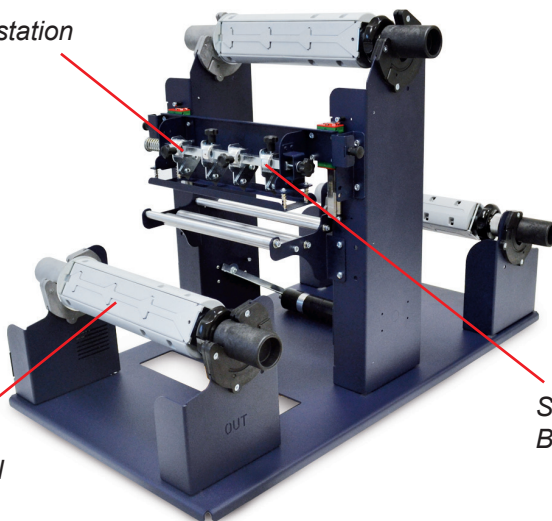

Legend

MCH: MOTORIZED CORE HOLDER



## Note on Media Environment:

*50% humidity and 72 degrees Fahrenheit is the optimal conditions for both storage and use of label stock. Store label stock in protective plastic wrappings. Rewrap partially used stock. Do not store stock directly on concrete floors.*

*Label stock should be conditioned in this environment for 72 hours prior to use. Failure to store media in these conditions may result in media tension problems. Too much humidity will cause labels to curl on the edges.*

## RUN A JOB

---



**WARNING:** Before starting a new job, always make sure the waste matrix from the previous job has been removed.

Do not attach the matrix from a different size label to an existing roll.

This will cause an uneven wrap which will cause the material to walk.

1

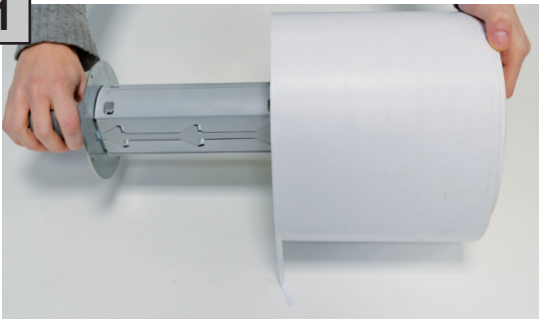

Load the printed and die cut roll on the supply mandrel (non-motorized).

Push until it touches roll guide.

2

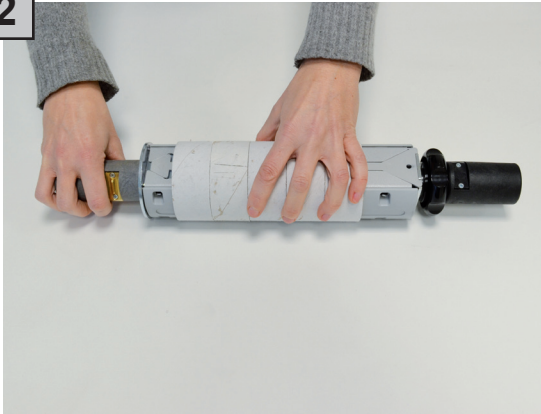

Place an empty wide core on the mandrel (motorized).

Push the core until it touches the core stop. Tighten using the tension knob.

3

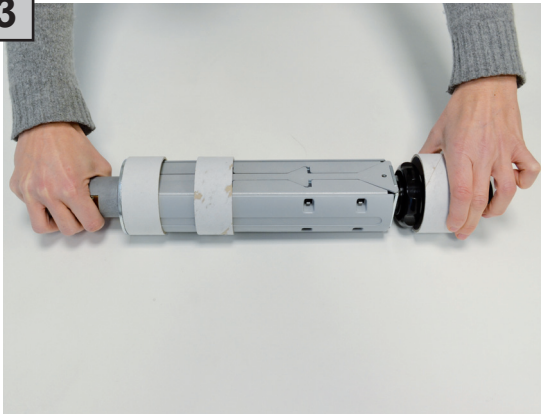

Insert the empty cardboard core on the MCH (motorized) to receive the new labels roll.

4

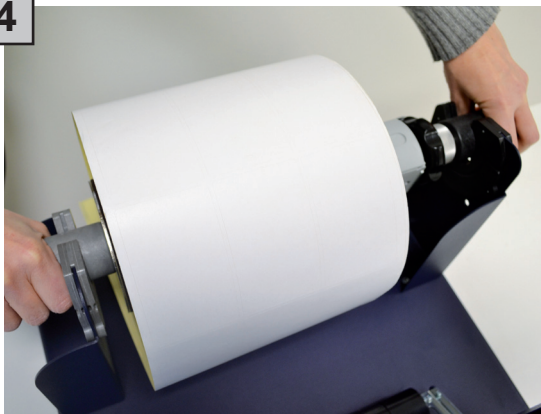

Set the supply mandrel in the supply location. Match the gray handle to gray holder.

5

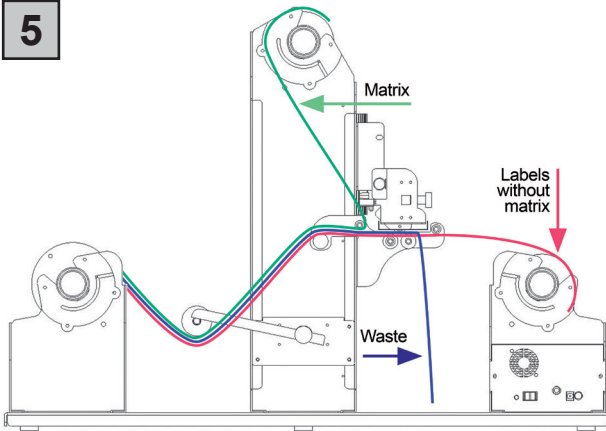

Paper path.

6



Pull the printed labels for about fifty centimeters.

7



Set the weeder mandrel in the weeder location on the top of the MCH.

8



Separate the matrix from liner at this point.

9



the matrix to the empty core on the weeder mandrel.

10

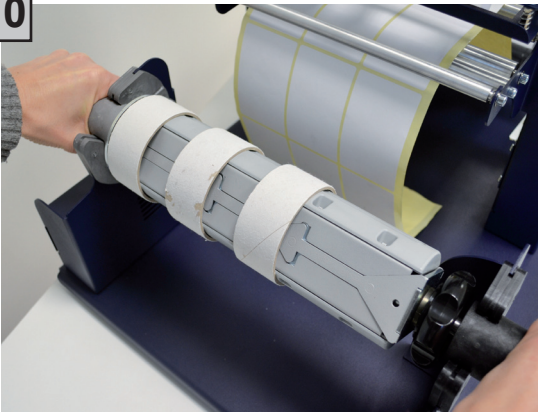

Insert the MCH into the lower matrix support.

11

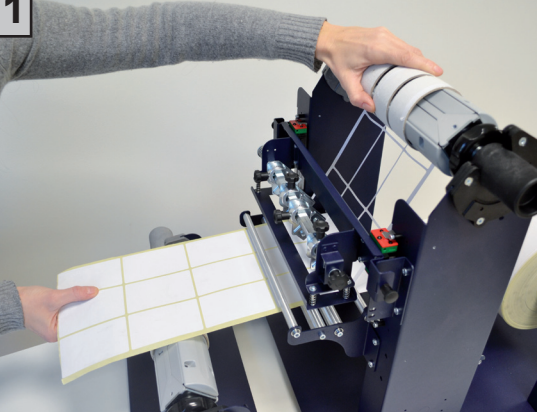

Continue pulling the printed labels and manually turning the weeder mandrel so that the matrix is wrapped around the core at least once.

12



1. Move the printed label behind the lower MCH

2. Position the empty cardboard core on the single future new labels roll

3. Tighten the roll and the guide in place by turning the tension knob.

13

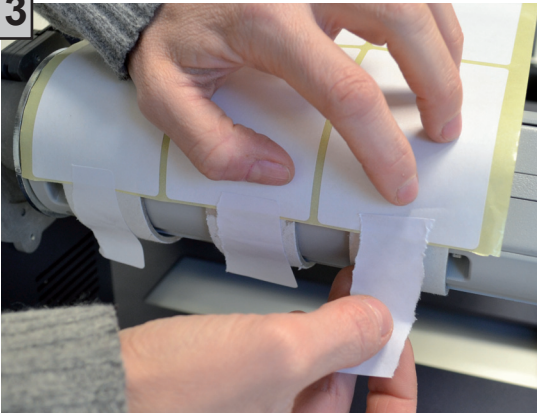

Temporarily attach the label directly to the take-up mandrel.

This will provide the necessary tension in order to start the slitting process.



14

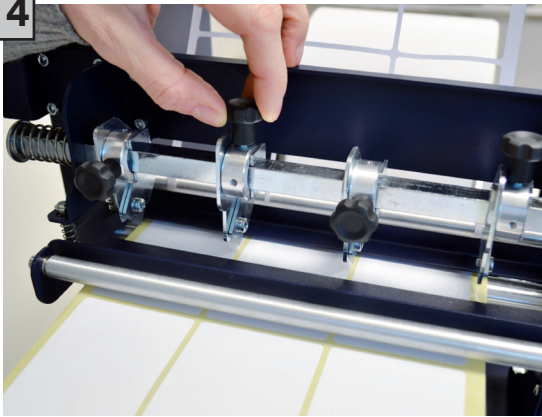

Position the blades in between each column and on either edge if desired.

You can alternate the position of the thumb screw from the top to the side to gain easier access.

**WARNING!**

The slitter blades are exposed and **VERY** sharp when the slitter station is in the “up” position. Use extreme caution!

A

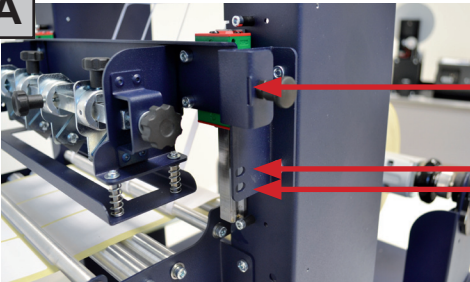

A

B

C



B

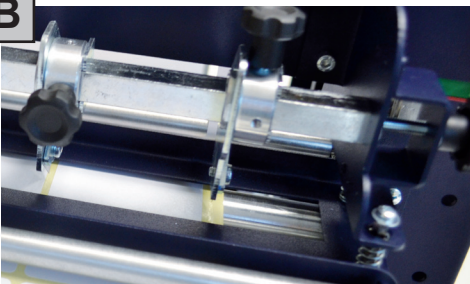

C

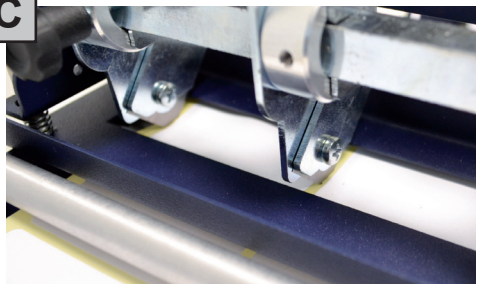

**Slitter module has 3 positions:**

- Upper position (A), the blades are closed to allow the media loading;
- Middle position (B), align the blades with the edges and the center of the labels, tighten the thumb screw once the blade is in position;
- Lower position (C), the blade cut the media.



The black knobs lock the slitter module in the requested position. Screw the thumb knobs to move the blades to the right or to the left.

15



Turn on the MATRIX REMOVER using the power switch on the back.

Make sure the speed knob is in the slowest position before you switch on the MATRIX REMOVER.

16



Slowly turn the speed knob.

Run the machine until the slit labels reach the bottom of the take-up mandrel.

17

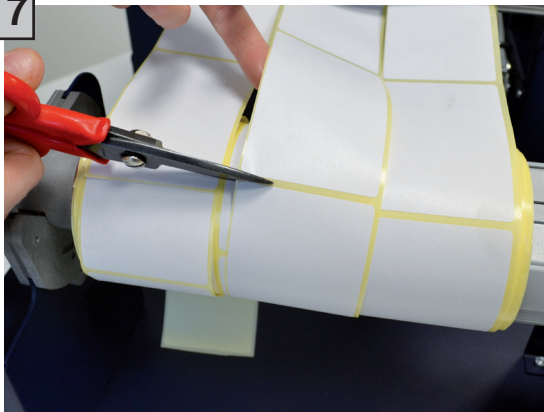

Remove the labels that have wrapped around the take-up mandrel.

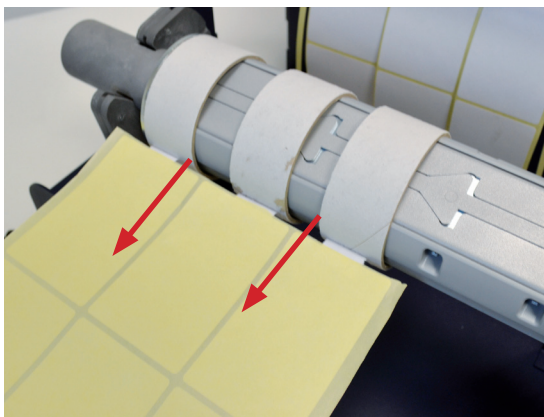

18

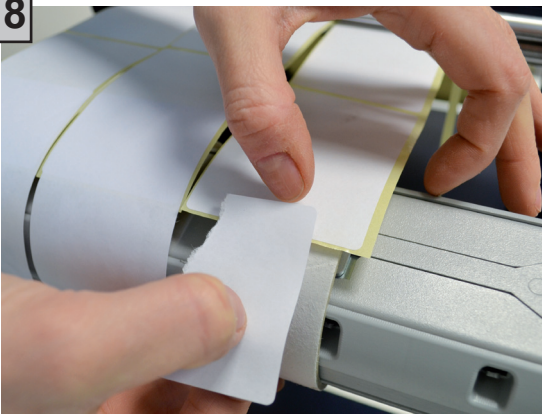

Attach the labels to the core using waste label or tape.





**Note:**

*Make sure the tension on all rolls is even. If they are not even and you have already attached them to the core you can easily equalize them by loosening the tension knob on the mandrel just a little. Now turn each core on the mandrel until all label rolls are taut. Tighten the knob again.*

19

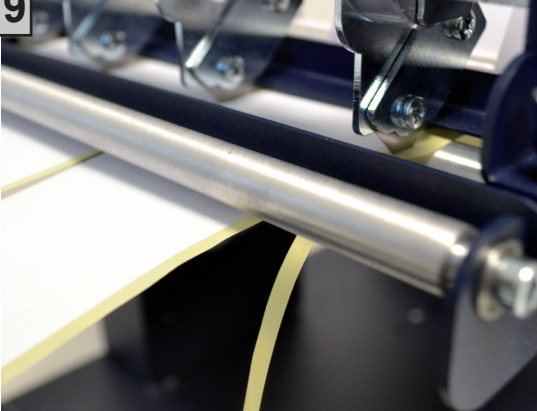

Feed the edge waste under the edge waste roller.

20

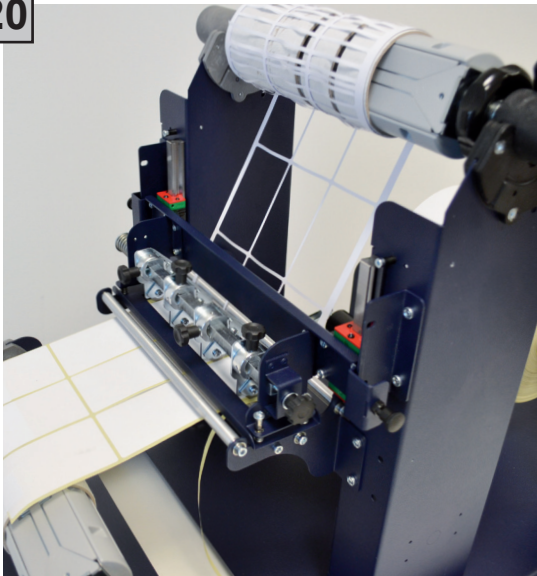

Switch on the MATRIX and slowly turn to increase the speed. Evaluate the following areas:

- 1. Matrix Release**
- 2. Matrix Mandrel Wrapping**
- 3. Slitting**
- 4. Finished Cores**

21

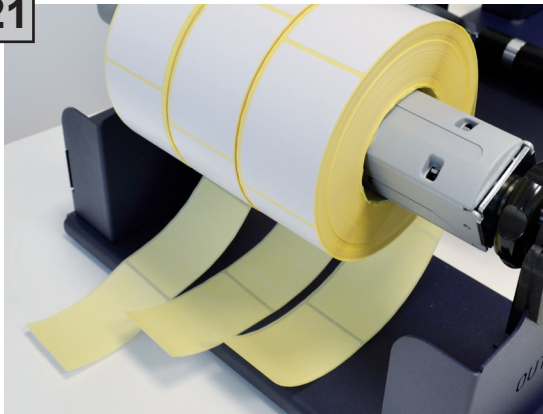

When the roll is finished, the unit automatically stops when the contact on the dancer arm touches the screw on the base.

You will also hear an audible tone.

22

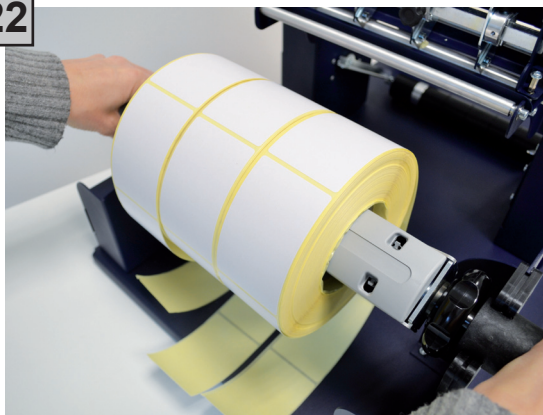

Remove the finished rolls from the take up location.

23

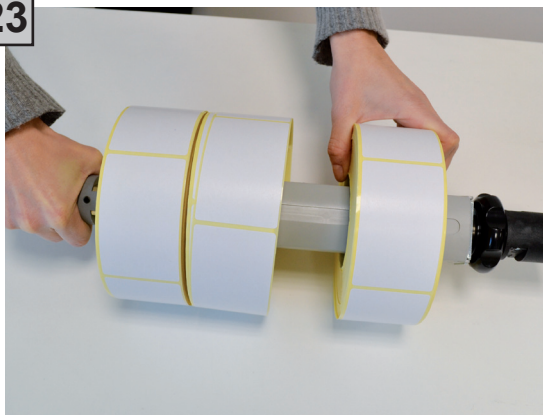

Remove the rolls from the take-up mandrel.

24

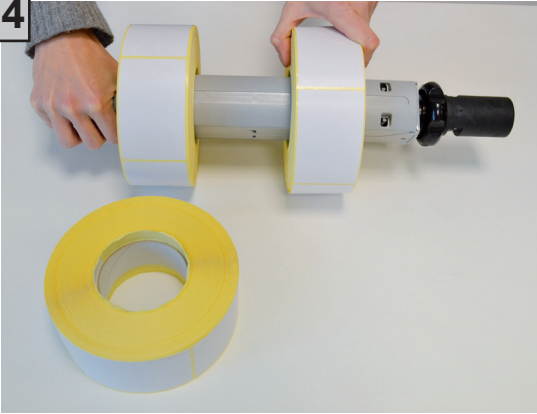

Separate the finished rolls. Some interleaving may occur.

**This is normal.**

25

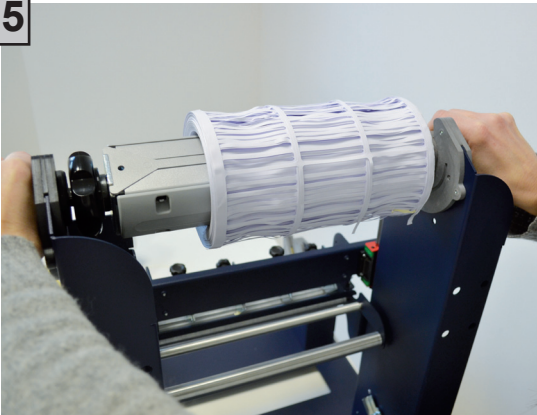

Finally, remove the waste matrix mandrel and discard the matrix and the core.

We do not recommend reusing the same core with matrix from a previous job still attached.

## HOW TO ADD OR REMOVE A BLADE HOLDER

---

1

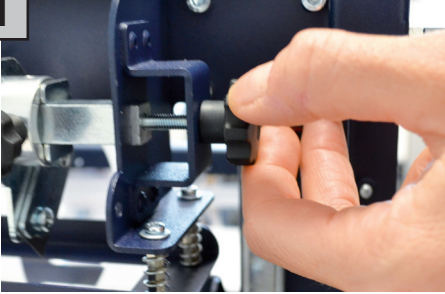

Keep out the iron slide bar unscrewing the thumb screw.

2

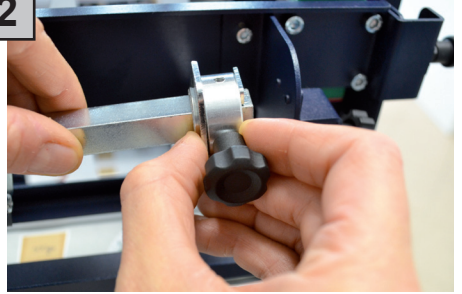

Slide in or out the blade holder. Relocate the slide iron bar in its position and rescrew the thumb screw.

## REPLACING SLITTER BLADES

---

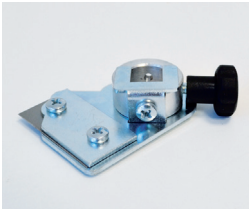

Loosen the two screws holding the blade in place.

Replace the blade.

Fix back the screw to holding the blade in place.

## HOW TO ADJUST THE CLUTCH ON UNWINDER

---

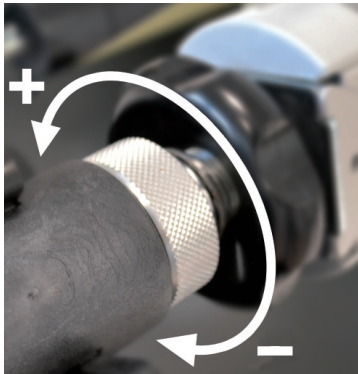

It is possible to adjust the clutch by just screwing or loosening the aluminium handle on it.

**+ more clutch**

**- less clutch**

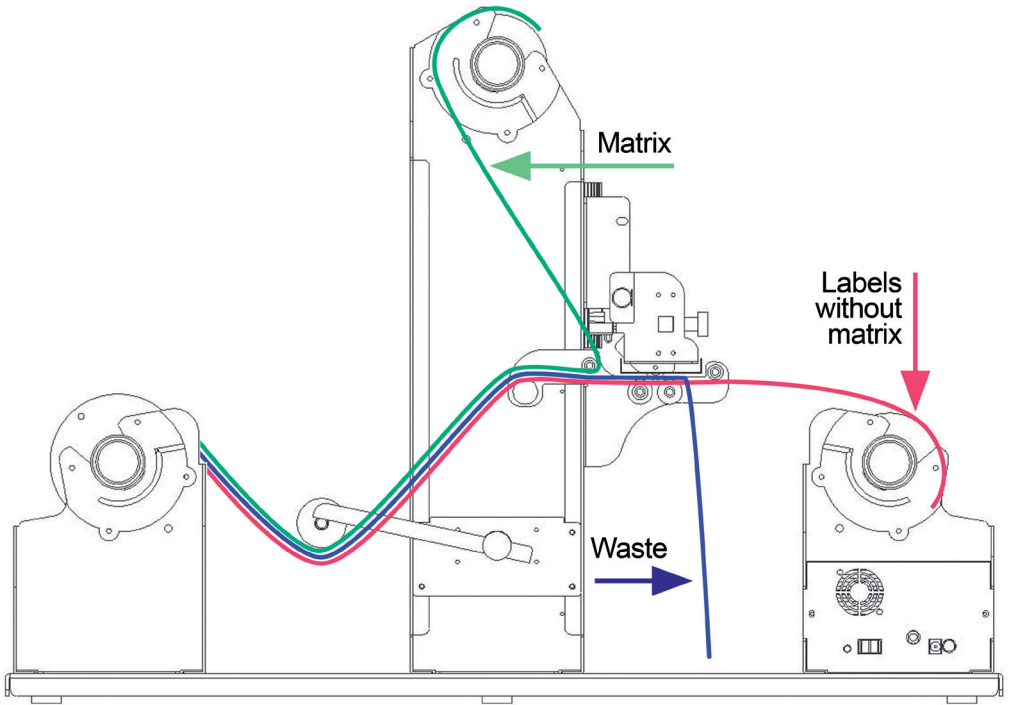

***Paper path***





## **Warnings**

- The main plug of power supply cord set of AC/DC power supply is considered as disconnecting device of equipment.
- Do not operate the Matrix Remover while wearing loose fitting clothing or neck ties. Serious injury may result. If clothing or fingers are caught in the rollers, immediately disconnect the D.C. connector.
- Keep your hands away from the Matrix Remover at all times while the unit is running.
- When replacing Slitter blades work from the back blade housing to the front. This will minimize the chance of injury since you will not be working over already installed blades.
- When transporting the unit or any time the unit is not in use always lower the slitter station into the down/cut position. This will prevent accidental contact with the slitter blades. The two rollers below the slitter station act as a guard when the slitter station is in the down position.
- To prevent fire or shock hazard, do not expose the unit to rain or moisture. Operate the unit with only proper electrical specifications as labeled on the unit and the AC adapter.

**WARNING**  
**HAZARDOUS MOVING PARTS**  
**KEEP FINGERS AND OTHER BODY PARTS AWAY**

**FCC Compliance Statement:** This device complies with part 15 of the FCC rules. Operation is subject to the following two conditions: (1) this device may not cause harmful interference, and (2) this device must accept any interference received, including interference that may cause undesired operation.

**For Users in the United States:** This product is intended to be supplied by AC/DC Power Supply delivered with the machine as for the UL regulation tested and certificated together. This equipment has been tested and found to comply with the limits for a Class A digital device, pursuant to Part 15 of the FCC Rules. In a domestic environment this product may cause radio Interference In which case the user may be required to take adequate measures. This equipment generates, uses, and can radiate radio frequency energy and, if not installed and used in accordance with the instructions, may cause harmful interference to radio communications. However, there is no guarantee that interference will not occur in a particular installation, If this equipment does cause harmful interference to radio or television reception, which can be determined by turning the equipment off and on, the user is encouraged to try to correct the interference by one or more of the following measures:

- Re-orient or relocate the receiving antenna.
- Increase the separation between the equipment and receiver.
- Connect the equipment into an outlet on a circuit different from that to which the receiver is connected.
- Consult the dealer or an experienced radio/TV technician for help.

Use of shielded cables is required to comply with the Class A limits of Part 15 of the FCC Rules. You are cautioned that any changes or modifications not expressly approved in this manual could void your authority to operate and/or obtain warranty service for this equipment.



## **Avertissements**

- La prise de l'alimentateur AC/DC est considéré comme partie qui deconnecte l'appareil.
- Ne fonctionnent pas à la Matrix Removeur tout en portant des vêtements lâches ou liens du cou. Peuvent entraîner des blessures graves. Si les vêtements ou les doigts sont pris dans les rouleaux, appuyez immédiatement deconnectez le connecteur D.C.
- Gardez vos mains loin de la Matrix Removeur en tout temps pendant l'exécution de l'unité.
- Lorsque le remplacement des lames de coupeuse travaillent à partir du logement de la lame arrière vers l'avant. Cela réduira les risques de blessures puisque vous travaillerez pas au-dessus des lames déjà installés.
- Lors du transport de l'unité ou toute fois l'unité n'est pas dans l'utilisation toujours plus faible la station coupeuse en position down/coupe. Cela empêchera le contact accidentel avec les lames de coupeuse. Les deux rouleaux sous la station de coupeuse agissent comme un garde lorsque la station de la coupeuse est dans la position vers le bas.
- Pour prévenir les risques d'incendie ou de choc, n'exposez pas l'unité de la pluie ou l'humidité. Faire fonctionner l'unité avec les spécifications électriques que comme marqué sur l'unité et l'adaptateur ca.

### **ATTENTION**

#### **PIECES DANGEREUSES EN MOUVEMENT**

**N'APPROCHEZ PAS LES DOIGTS ET AUTRES PARTIES DU CORPS**

**FCC Compliance Statement:** This device complies with part 15 of the FCC rules. Operation is subject to the following two conditions: (1) this device may not cause harmful interference, and (2) this device must accept any interference received, including interference that may cause undesired operation.

**For Users in the United States:** This product is intended to be supplied by AC/DC Power Supply delivered with the machine as for the UL regulation tested and certificated together. This equipment has been tested and found to comply with the limits for a Class A digital device, pursuant to Part 15 of the FCC Rules. In a domestic environment this product may cause radio Interference In which case the user may be required to take adequate measures. This equipment generates, uses, and can radiate radio frequency energy and, if not installed and used in accordance with the instructions, may cause harmful interference to radio communications. However, there is no guarantee that interference will not occur in a particular installation, If this equipment does cause harmful interference to radio or television reception, which can be determined by turning the equipment off and on, the user is encouraged to try to correct the interference by one or more of the following measures:

- Re-orient or relocate the receiving antenna.
- Increase the separation between the equipment and receiver.
- Connect the equipment into an outlet on a circuit different from that to which the receiver is connected.
- Consult the dealer or an experienced radio/TV technician for help.

Use of shielded cables is required to comply with the Class A limits of Part 15 of the FCC Rules. You are cautioned that any changes or modifications not expressly approved in this manual could void your authority to operate and/or obtain warranty service for this equipment.